

**A** Upright Post

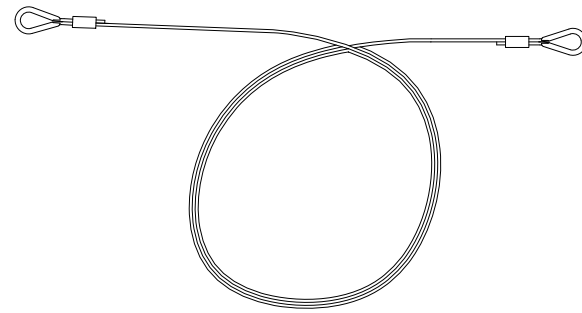

**B** Top Cable

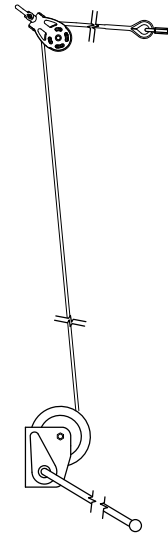

**C** Tension End Lifting Assembly

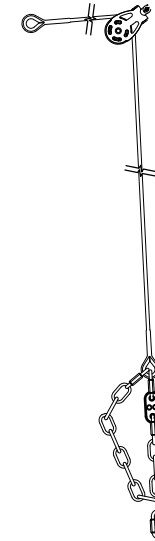

**D** Anchor End Lifting Assembly

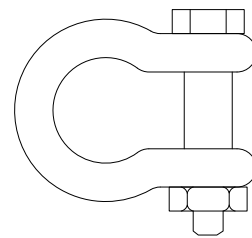

**E** Shackle

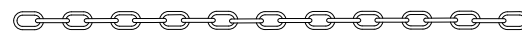

**F** Chain Door Weight

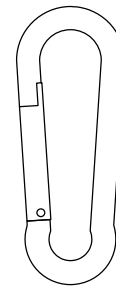

**G** Snap Hook

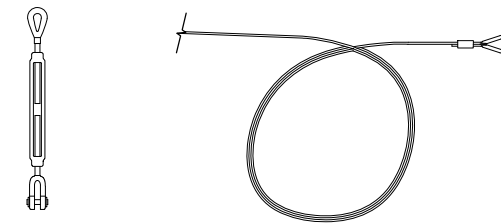
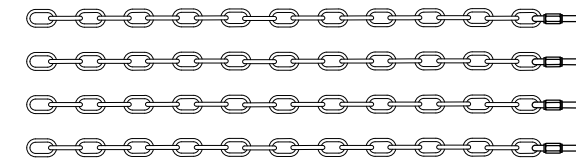

**H** Ground Cable Kit  
NOT ALL ITEMS SHOWN

**PARTS LIST**

Sheet ID	QTY	DESCRIPTION
A	6	Upright Post
B	3	Top Cables (69'-6" L for 70' Cages <i>or</i> 54'-6" L for 55' Cages)
C	3	Tension End Lifting Assembly
D	3	Anchor End Lifting Assembly
E	6	3/8" Shackle
F	1	Chain Door Weight (36" L)
G	VARIES	Snap Hooks (140 for 70' Cages <i>or</i> 110 for 55' Cages)
H	1	Gound Cable Kit (See Attached Dwg Pkg.)
-	X	120# Cable Ties 8" (pack)
-	1	Premium Cage Net 70' L x 14' W x 14' H <i>or</i> Premium Cage Net 55' L x 14' W x 14' H

This is a standard Beacon Athletics product.  
Any changes must be explicitly authorized and approved by Beacon Athletics.

REVISION #	DATE	BY

SCALE:	SEE DWG
DRAWN BY:	EH
DATE:	09/22/2017
MODEL:	TFP70-1HST
PART #:	105-100-490

DRAWING NO:  
**PS-1**

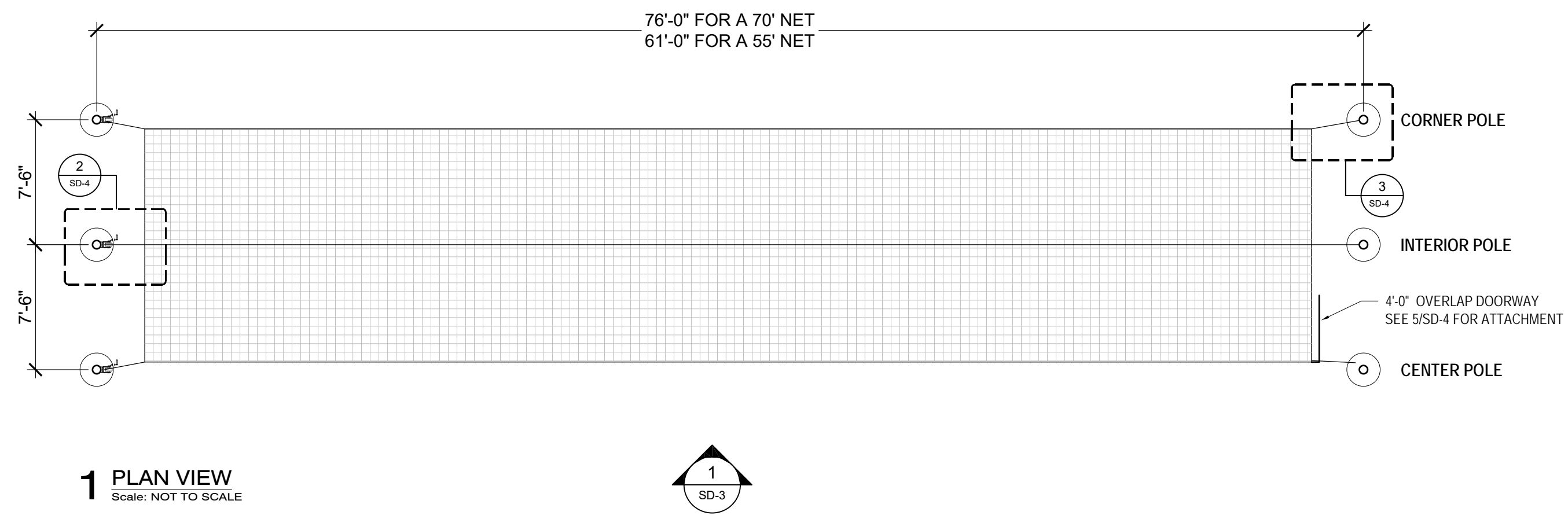

**1 PLAN VIEW**  
 Scale: NOT TO SCALE

DRAWING TITLE: **TUFFframe™ PRO HOISTABLE OUTDOOR 70' BATTING CAGE - SINGLE LAYOUT**

CUSTOMER NAME: -  
 PROJECT NAME: -  
 PROJECT LOCATION: -

REVISION #	DATE	BY

SCALE:	SEE DWG
DRAWN BY:	EH
DATE:	09/22/2017
MODEL:	TFP70-1HST
PART #:	105-100-490
DRAWING NO:	<b>SD-2</b>

This is a standard Beacon Athletics product.  
 Any changes must be explicitly authorized and approved by Beacon Athletics.

REVISION #	BY	DATE

SCALE: SEE DWG  
DRAWN BY: EH  
DATE: 09/22/2017  
MODEL: TFP70-1HST  
PART #: 105-100-490

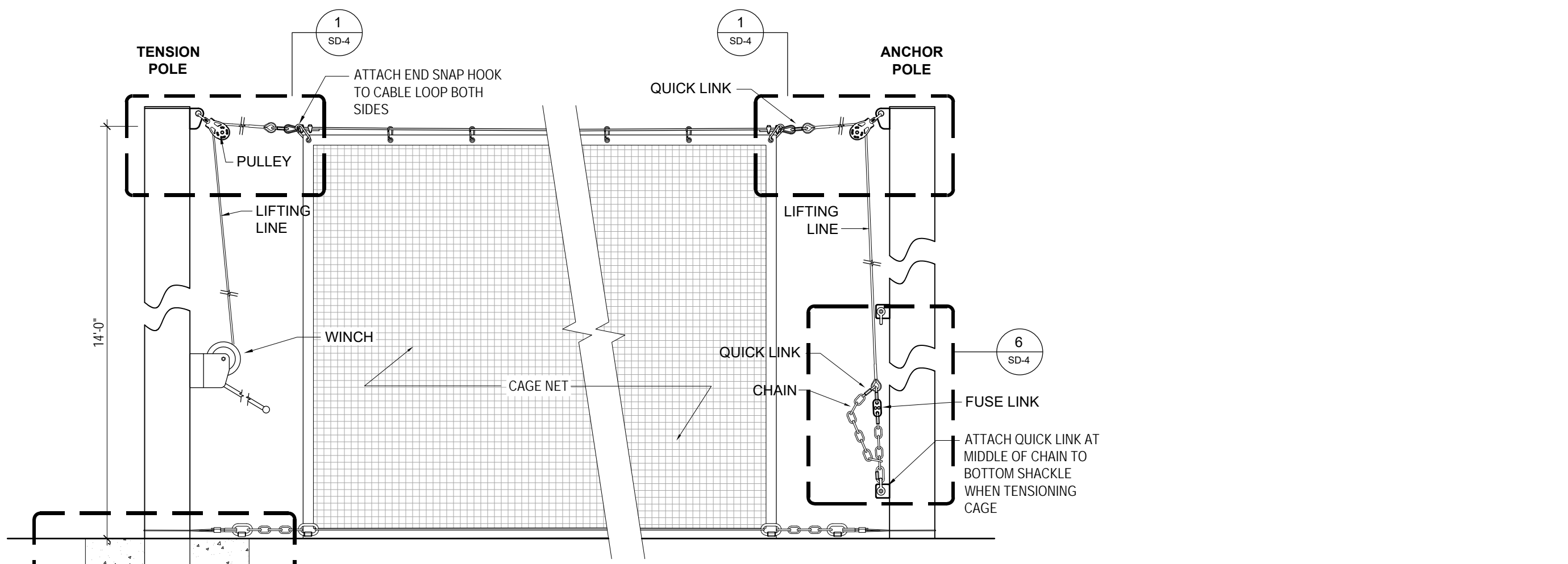

**1 SIDE ELEVATION WHEN TENSIONED**  
Scale: 3/4" = 1'-0"

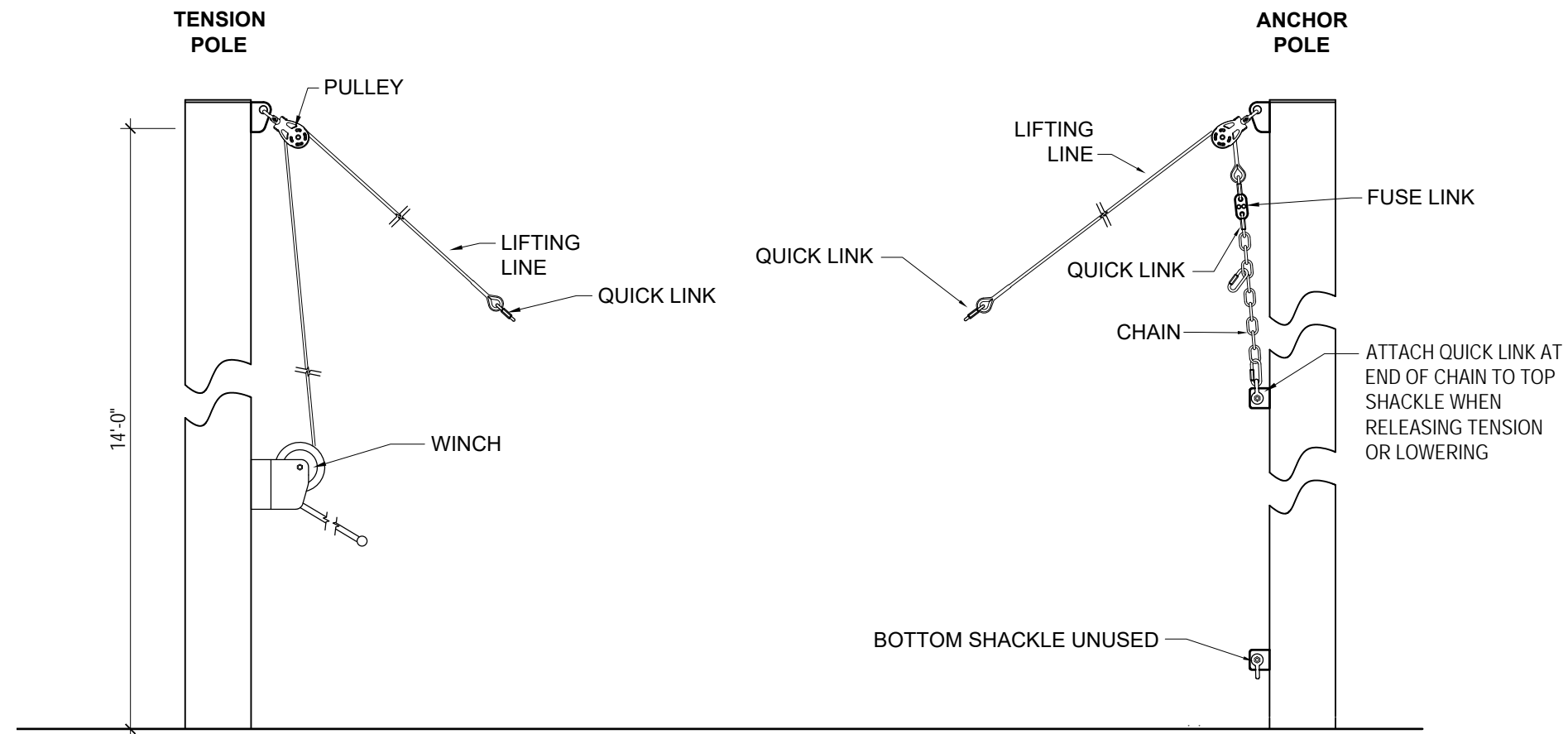

**2 SIDE ELEVATION WHEN NOT TENSIONED**  
Scale: 3/4" = 1'-0"

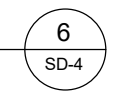

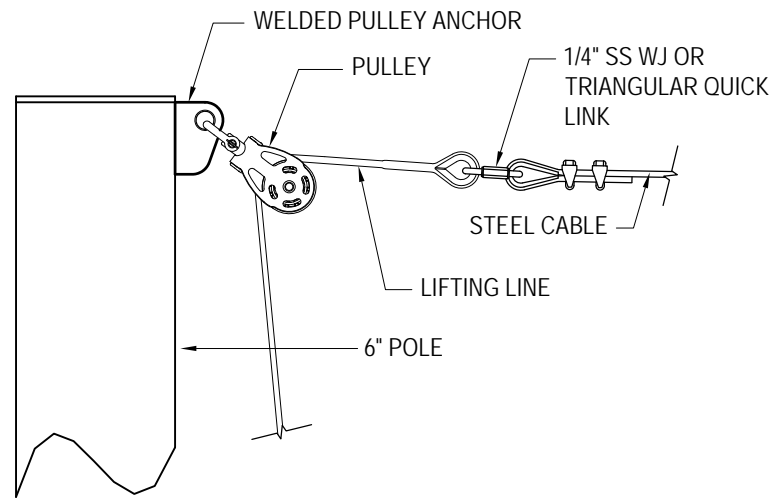

**1 CABLE CONNECTION - SIDE VIEW**  
Scale: 1 1/2" = 1'-0"

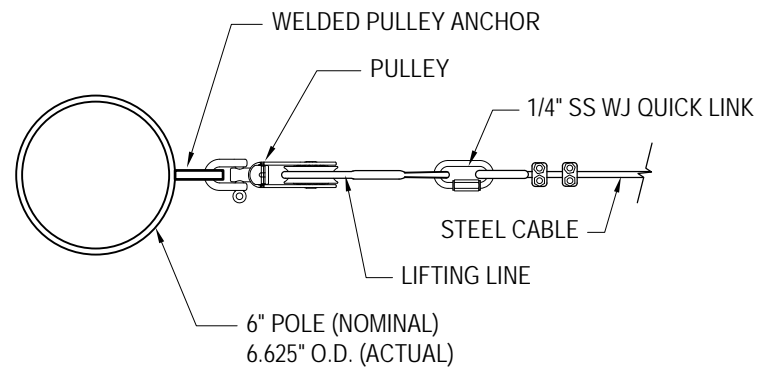

**2 CORNER POLE CABLE - TOP VIEW**  
Scale: 1 1/2" = 1'-0"

**3 NOT USED**  
Scale: 1 1/2" = 1'-0"

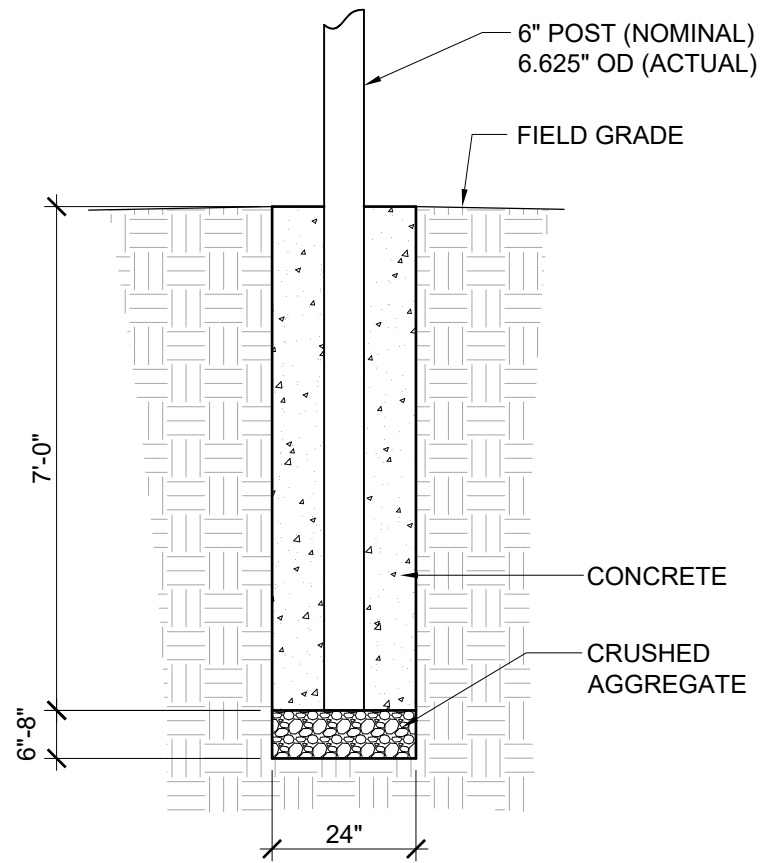

**4 FOOTING DETAIL**  
Scale: 3/8" = 1'-0"

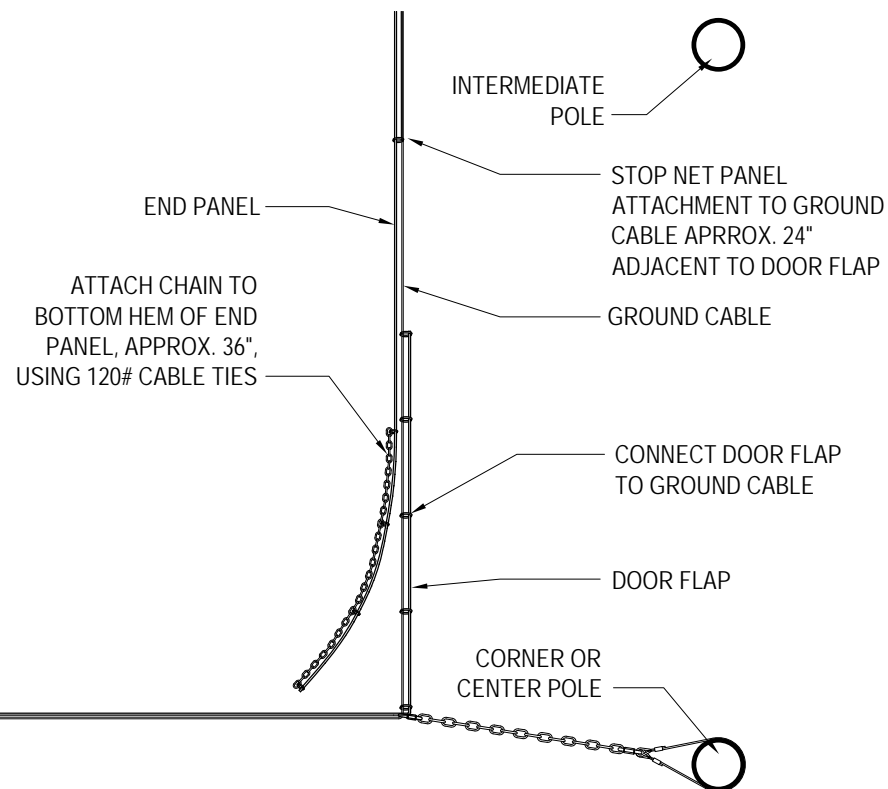

**5 DOOR FLAP ATTACHMENT**  
Scale: Not to Scale

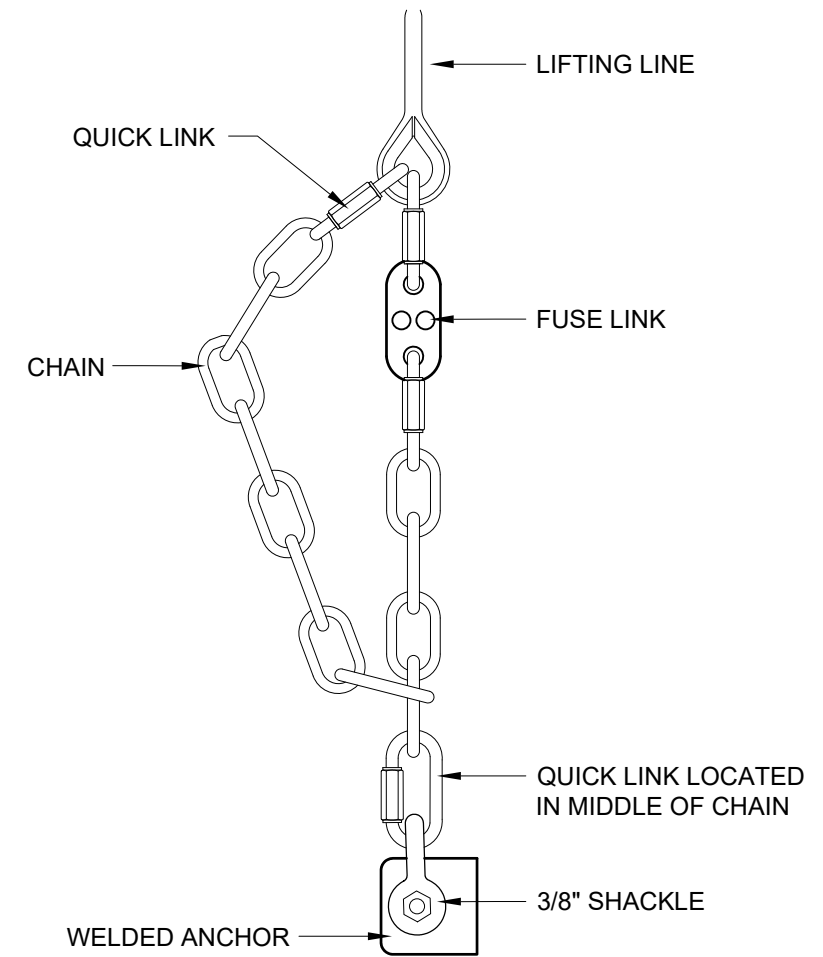

**6 ANCHOR END CHAIN DETAIL**  
Scale: 3" = 1'-0"



© Copyright 2014 Beacon Athletics, Division of Rainbow Group, LLC.

DRAWING TITLE: **TUFFframe™ PRO HOISTABLE OUTDOOR 70' BATTING CAGE - SINGLE DETAILS**

CUSTOMER NAME: -  
PROJECT NAME: -  
PROJECT LOCATION: -

REVISION #	DATE	BY

SCALE: SEE DWG  
DRAWN BY: EH  
DATE: 09/22/2017  
MODEL: TFP70-1HST  
PART #: 105-100-490  
DRAWING NO:

**SD-4**

This is a standard Beacon Athletics product.  
 Any changes must be explicitly authorized and approved by Beacon Athletics.

**PARTS LIST**

DETAIL ID	QTY	DESCRIPTION
A	1	Eye-Jaw Turnbuckle
B	8	Wide Jaw Quick Links
C	4	Short Steel Cable
D	1	Long Cable Assembly (172'-0" for 70' Cage) (142'-0" for 55' Cage)
E	2	Cable Clamp
F	1	Thimble
G	4	24" Adjustment Chain
-	50	120# Cable Ties 8" (pack)

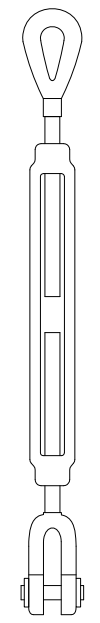

**A** Turnbuckle

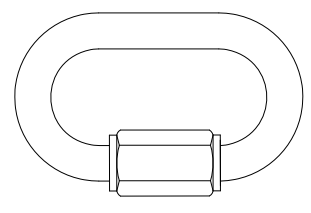

**B** Wide Jaw Quick Link



**C** Short Steel Cable

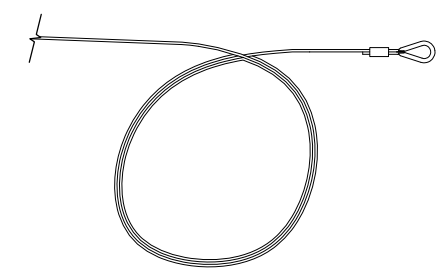

**D** Long Steel Cable

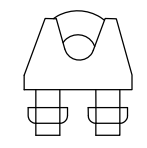

**E** Cable Clamp

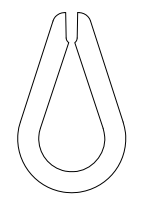

**F** Thimble

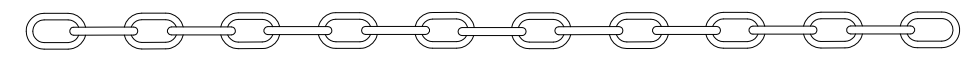

**G** ADJUSTMENT CHAIN

© Copyright 2014 Beacon Athletics,  
 Division of Rainbow Group, LLC.

DRAWING TITLE:  
**GROUND CABLE KIT**  
**PARTS LIST AND IDENTIFICATION**

CUSTOMER NAME: -  
 PROJECT NAME: -  
 PROJECT LOCATION: -

REVISION #	DATE	BY

SCALE:	NTS
DRAWN BY:	EH
DATE:	12/15/16
MODEL:	TFP70-1HST
PART #:	105-100-490
DRAWING NO:	<b>GC-1</b>

REVISION #	BY	DATE

SCALE:	NTS
DRAWN BY:	EH
DATE:	12/15/16
MODEL:	TFP70-1HST
PART #:	105-100-490
DRAWING NO:	

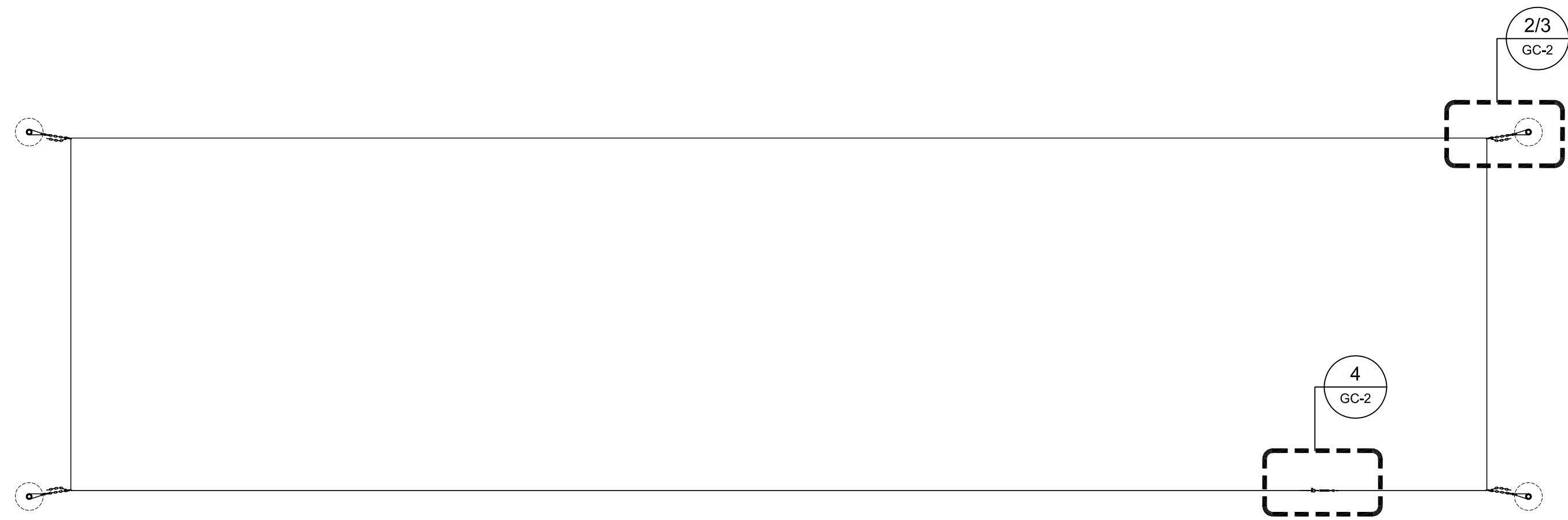

**1 GROUND CABLES**  
 Scale: NTS

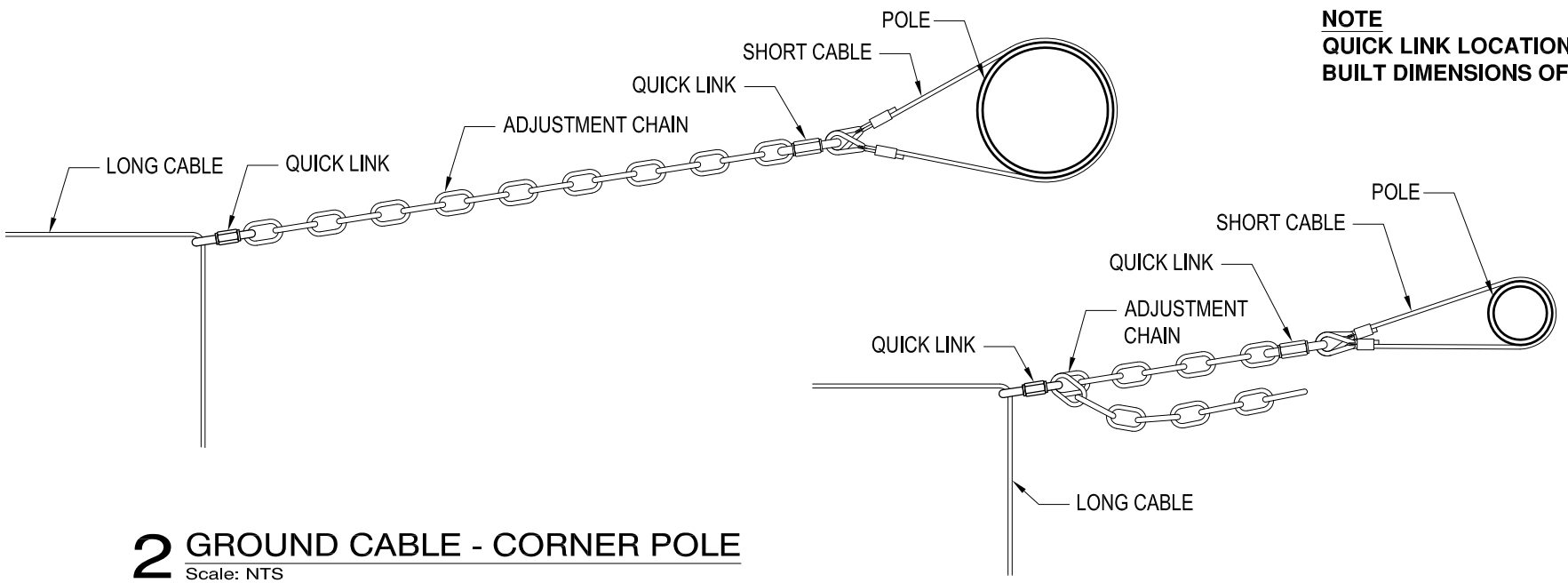

**2 GROUND CABLE - CORNER POLE**  
 Scale: NTS

**3 GROUND CABLE - CORNER POLE**  
 Scale: NTS

**NOTE**  
 QUICK LINK LOCATION ON ADJUSTMENT CHAIN TO BE DETERMINED BY FINAL AS BUILT DIMENSIONS OF BATTING CAGE

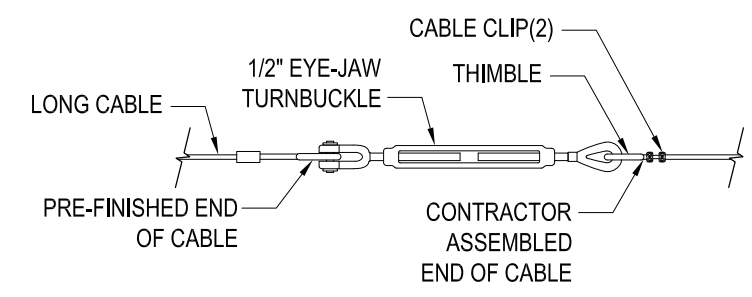

**4 GROUND CABLE - LONG CABLE CONNECTION**  
 Scale: NTS