

A Upright Post

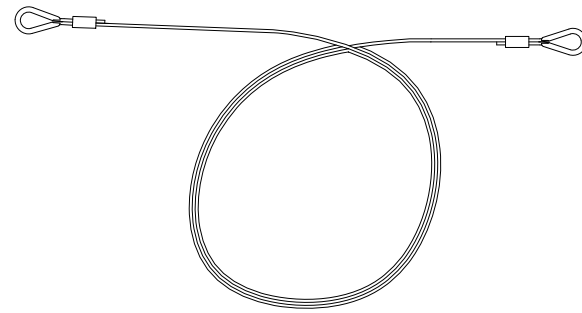

B Top Cable

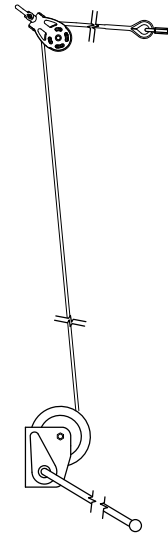

C Tension End Lifting Assembly

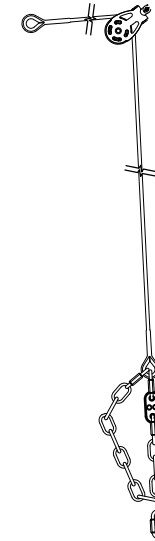

D Anchor End Lifting Assembly

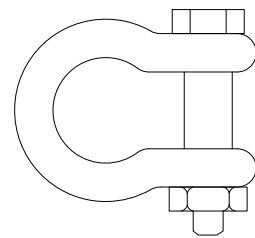

E Shackle

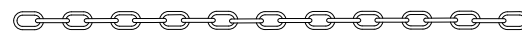

F Chain Door Weight

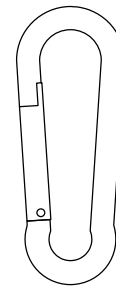

G Snap Hook

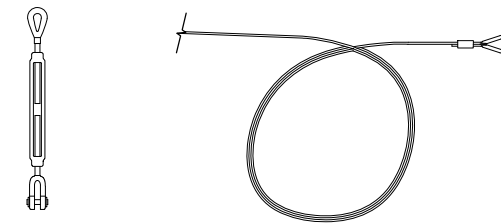
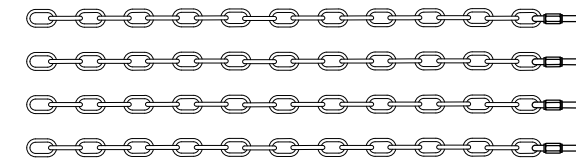

H Ground Cable Kit
NOT ALL ITEMS SHOWN

PARTS LIST

Sheet ID	QTY	DESCRIPTION
A	10	Upright Post
B	6	Top Cables (69'-6" L for 70' Cages <i>or</i> 54'-6" L for 55' Cages)
C	5	Tension End Lifting Assembly
D	5	Anchor End Lifting Assembly
E	10	3/8" Shackle
F	2	Chain Door Weight (36" L)
G	VARIES	Snap Hooks (280 for 70' Cages <i>or</i> 220 for 55' Cages)
H	2	Gound Cable Kit (See Attached Dwg Pkg.)
-	X	120# Cable Ties 8" (pack)
-	2	Premium Cage Net 70' L x 14' W x 14' H <i>or</i> Premium Cage Net 55' L x 14' W x 14' H

This is a standard Beacon Athletics product.
Any changes must be explicitly authorized and approved by Beacon Athletics.

REVISION #	DATE	BY

SCALE:	SEE DWG
DRAWN BY:	EH
DATE:	09/22/2017
MODEL:	TFP70-2HST
PART #:	105-100-495
DRAWING NO:	PS-1

DRAWING TITLE:
TUFFframe™ PRO HOISTABLE OUTDOOR 55' BATTING CAGE - DOUBLE LAYOUT

CUSTOMER NAME: -
PROJECT NAME: -
PROJECT LOCATION: -

REVISION #	DATE	BY

SCALE:	SEE DWG
DRAWN BY:	EH
DATE:	09/22/2017
MODEL:	TFP70-2HST
PART #:	105-100-495
DRAWING NO:	SD-2

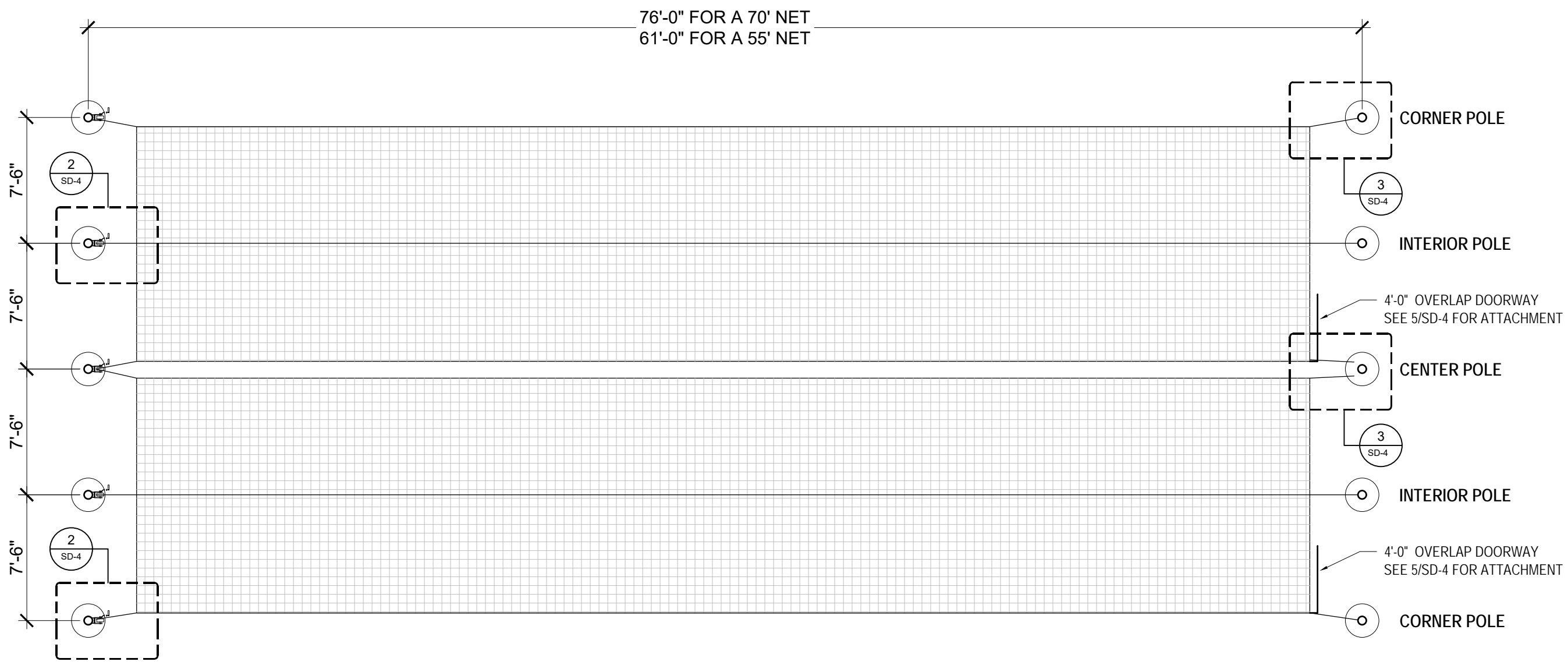

1 PLAN VIEW
Scale: NOT TO SCALE

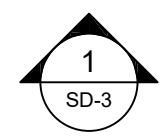

This is a standard Beacon Athletics product.
Any changes must be explicitly authorized and approved by Beacon Athletics.

DRAWING TITLE: **TUFFframe™ PRO HOISTABLE OUTDOOR 55' BATTING CAGE - DOUBLE ELEVATION & FOOTING DETAIL**

CUSTOMER NAME: -
 PROJECT NAME: -
 PROJECT LOCATION: -

REVISION #	BY	DATE

SCALE: SEE DWG
 DRAWN BY: EH
 DATE: 09/22/2017
 MODEL: TFP70-2HST
 PART #: 105-100-495

DRAWING NO: **SD-3**

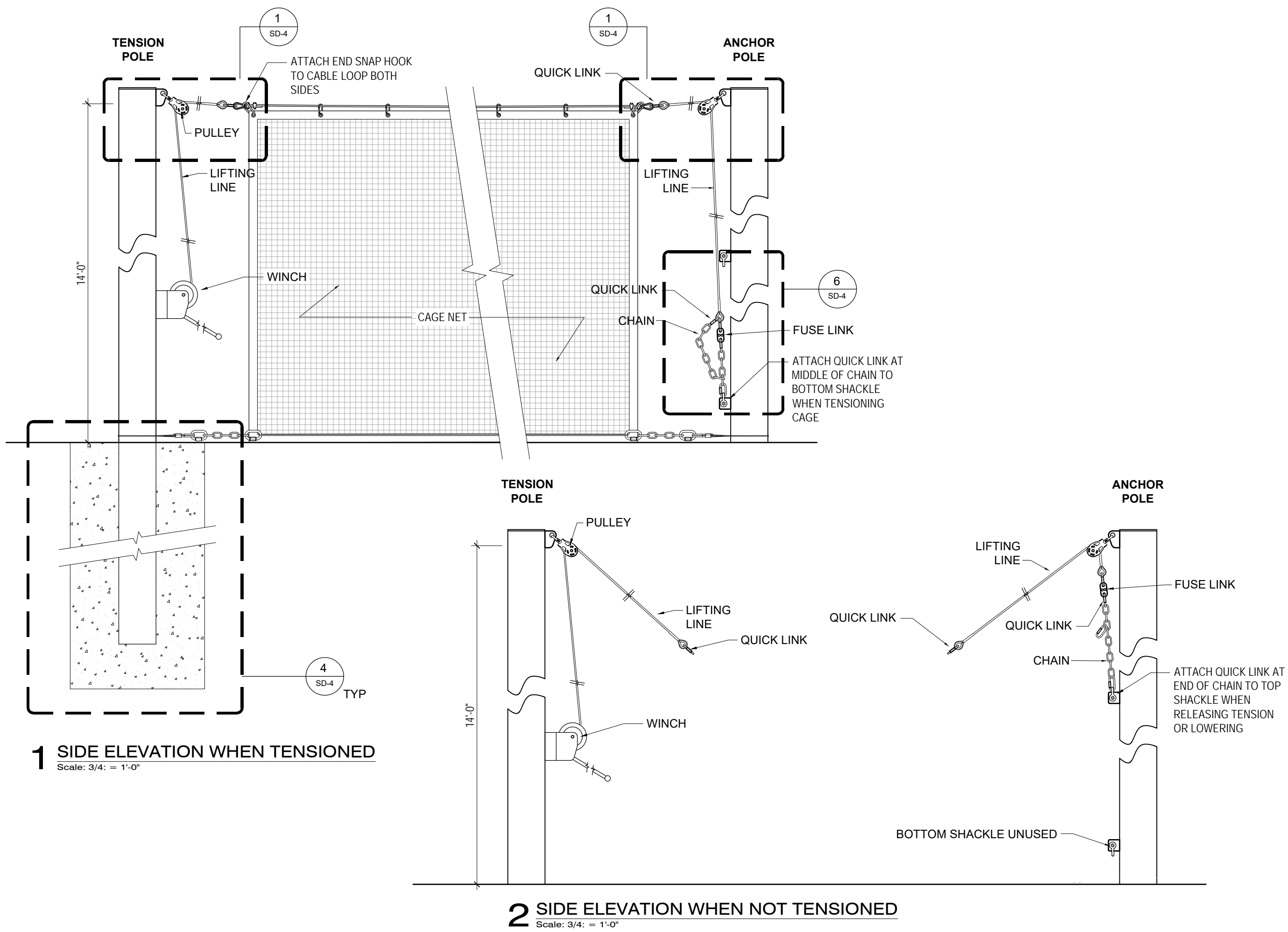

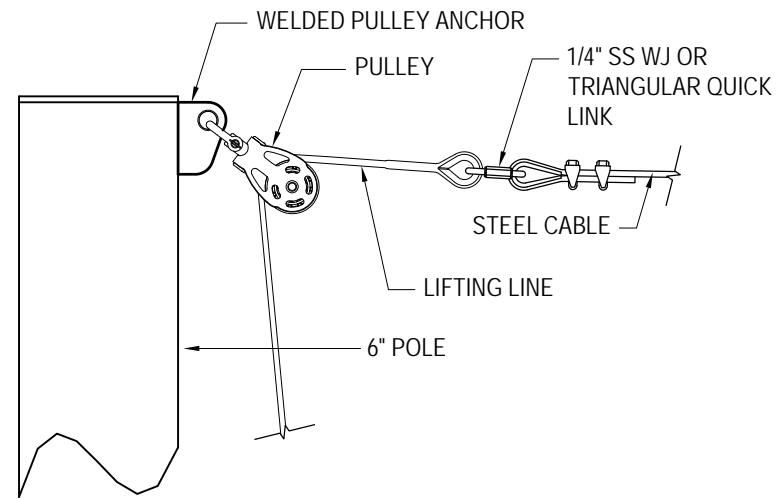

1 CABLE CONNECTION - SIDE VIEW
Scale: 1 1/2" = 1'-0"

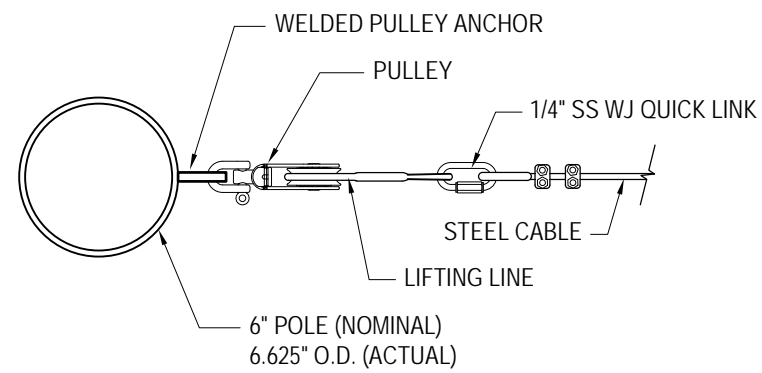

2 CORNER POLE CABLE - TOP VIEW
Scale: 1 1/2" = 1'-0"

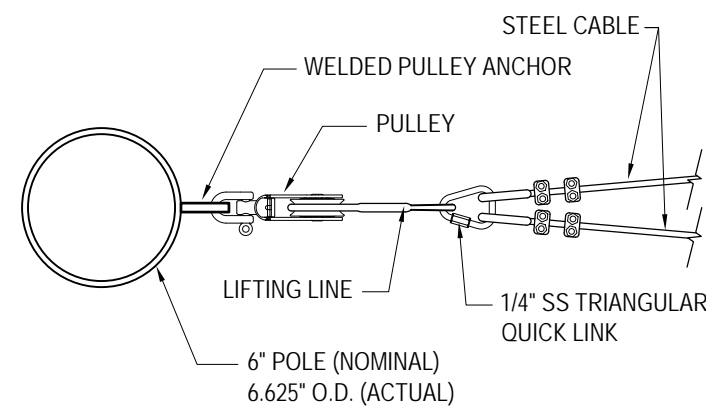

3 CENTER POLE CABLE - TOP VIEW
Scale: 1 1/2" = 1'-0"

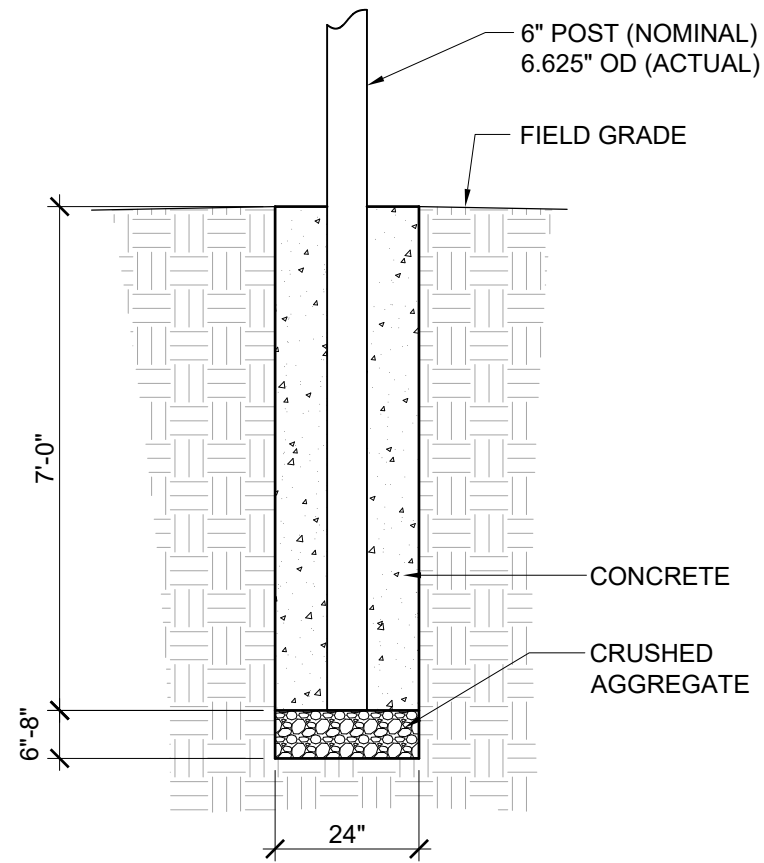

4 FOOTING DETAIL
Scale: 3/8" = 1'-0"

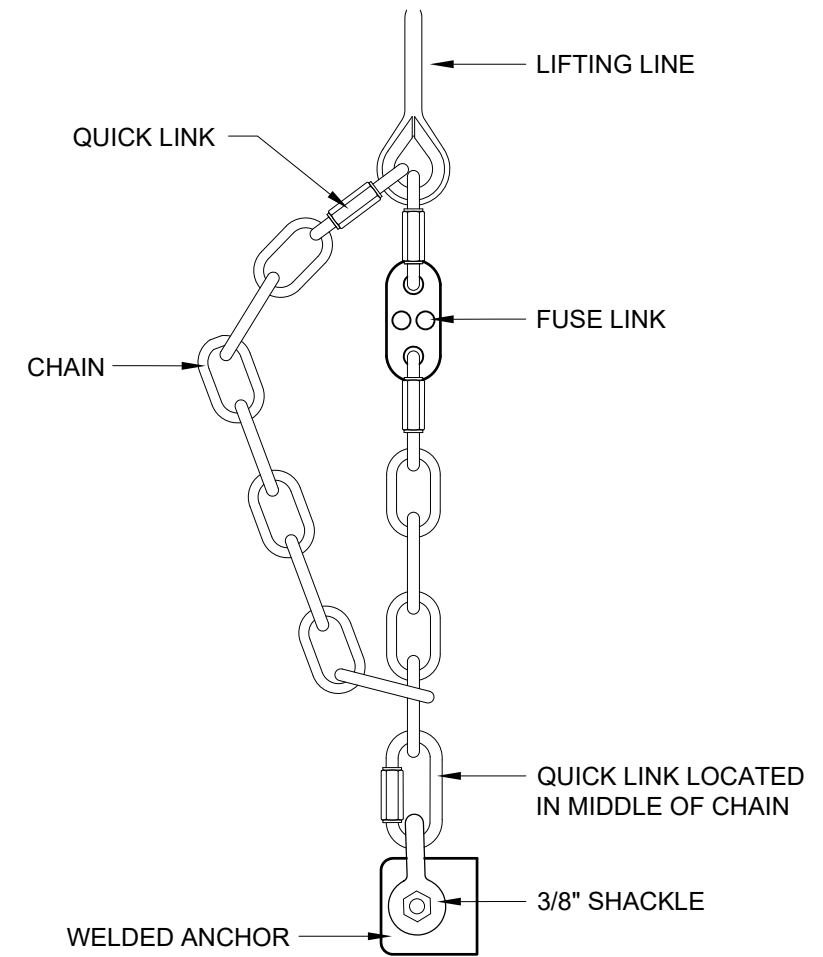

6 ANCHOR END CHAIN DETAIL
Scale: 3" = 1'-0"

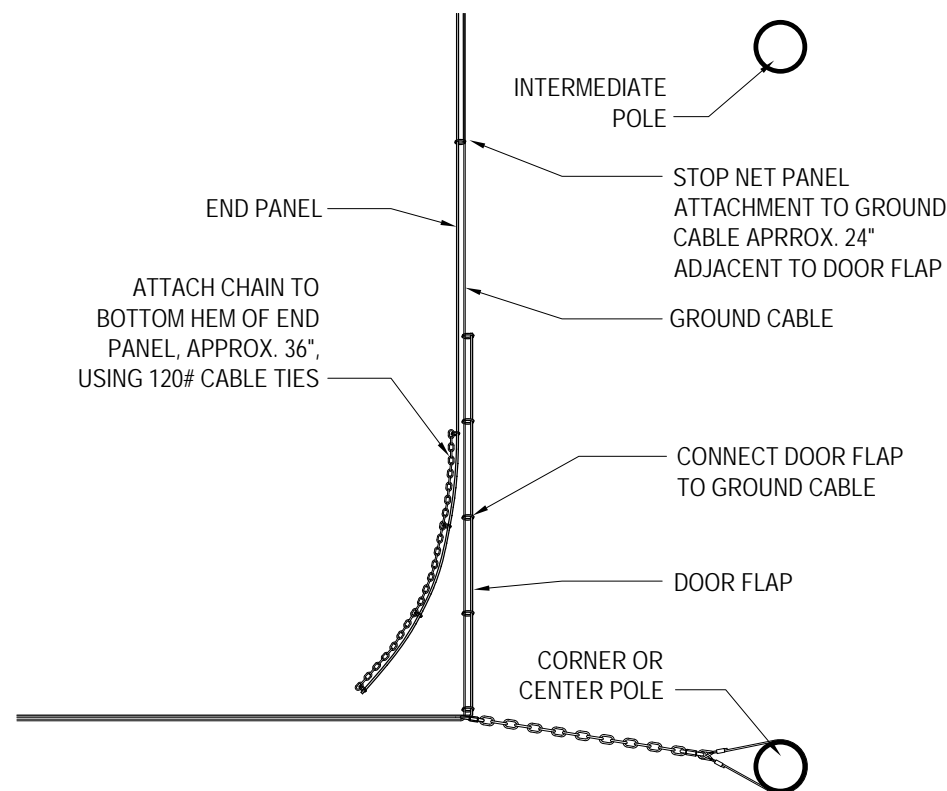

5 DOOR FLAP ATTACHMENT
Scale: Not to Scale



© Copyright 2014 Beacon Athletics, Division of Rainbow Group, LLC.

DRAWING TITLE: **TUFFframe™ PRO HOISTABLE OUTDOOR 55' BATTING CAGE - DOUBLE DETAILS**

CUSTOMER NAME: -
PROJECT NAME: -
PROJECT LOCATION: -

REVISION #	DATE	BY

SCALE:	SEE DWG
DRAWN BY:	EH
DATE:	09/22/2017
MODEL:	TFP70-2HST
PART #:	105-100-495
DRAWING NO:	

SD-4

This is a standard Beacon Athletics product.
 Any changes must be explicitly authorized and approved by Beacon Athletics.

PARTS LIST

DETAIL ID	QTY	DESCRIPTION
A	1	Eye-Jaw Turnbuckle
B	8	Wide Jaw Quick Links
C	4	Short Steel Cable
D	1	Long Cable Assembly (172'-0" for 70' Cage) (142'-0" for 55' Cage)
E	2	Cable Clamp
F	1	Thimble
G	4	24" Adjustment Chain
-	50	120# Cable Ties 8" (pack)

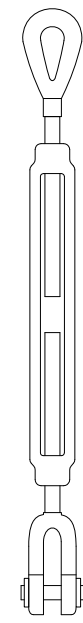

A Turnbuckle

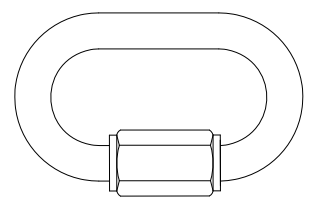

B Wide Jaw Quick Link



C Short Steel Cable

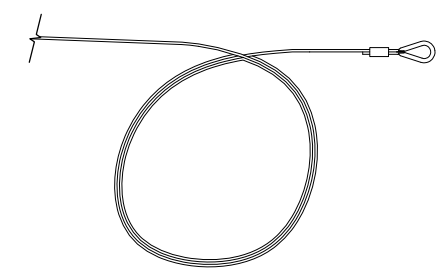

D Long Steel Cable

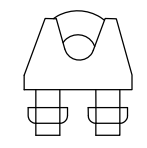

E Cable Clamp

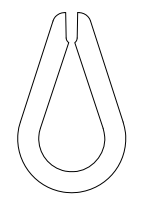

F Thimble

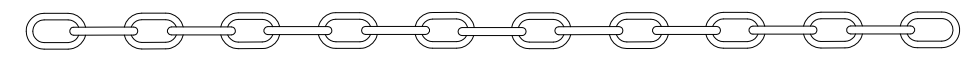

G ADJUSTMENT CHAIN

© Copyright 2014 Beacon Athletics,
 Division of Rainbow Group, LLC.

DRAWING TITLE:
GROUND CABLE KIT
PARTS LIST AND IDENTIFICATION

CUSTOMER NAME: -
 PROJECT NAME: -
 PROJECT LOCATION: -

REVISION #	DATE	BY

SCALE:	NTS
DRAWN BY:	EH
DATE:	12/15/16
MODEL:	TFP70-2HST
PART #:	105-100-495
DRAWING NO:	GC-1

REVISION #	BY	DATE

SCALE:	NTS
DRAWN BY:	EH
DATE:	12/15/16
MODEL:	TFP70-2HST
PART #:	105-100-495
DRAWING NO:	GC-2

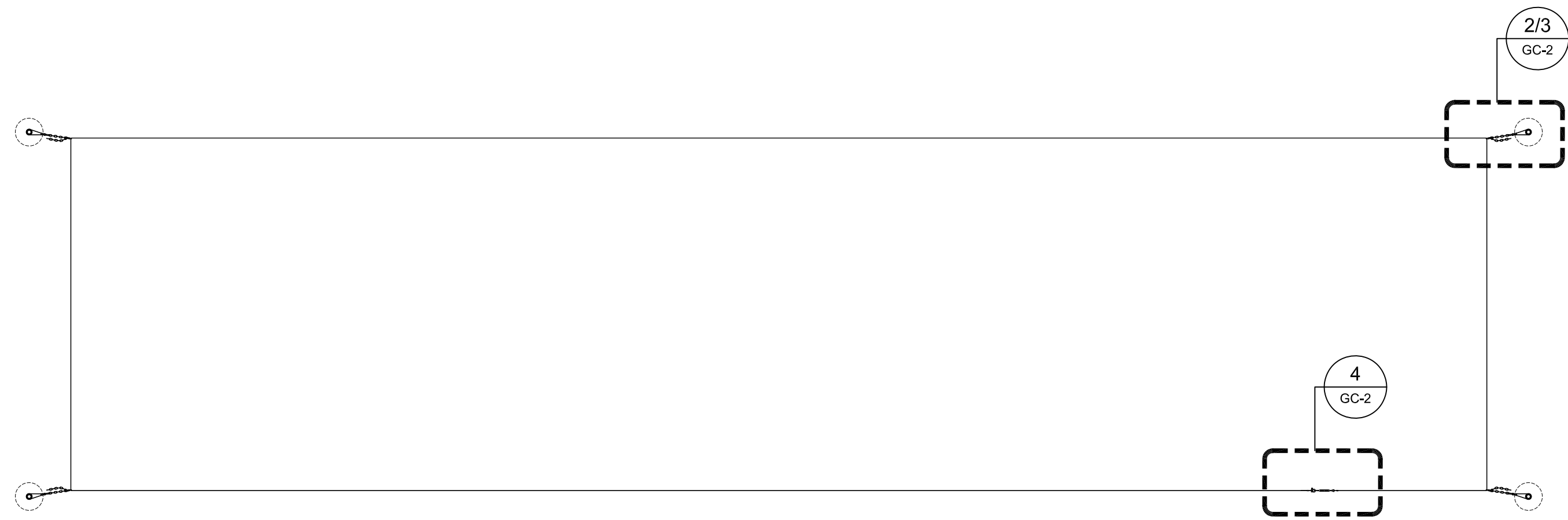

1 GROUND CABLES
Scale: NTS

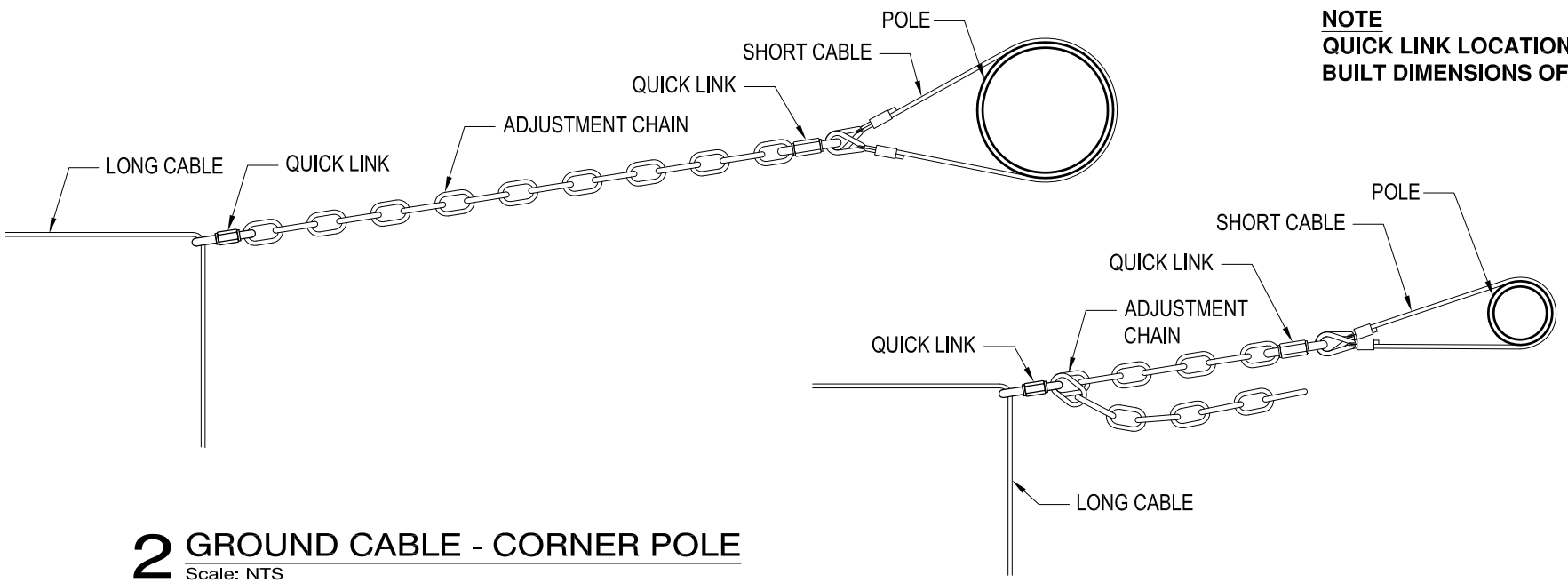

2 GROUND CABLE - CORNER POLE
Scale: NTS

3 GROUND CABLE - CORNER POLE
Scale: NTS

NOTE
QUICK LINK LOCATION ON ADJUSTMENT CHAIN TO BE DETERMINED BY FINAL AS BUILT DIMENSIONS OF BATTING CAGE

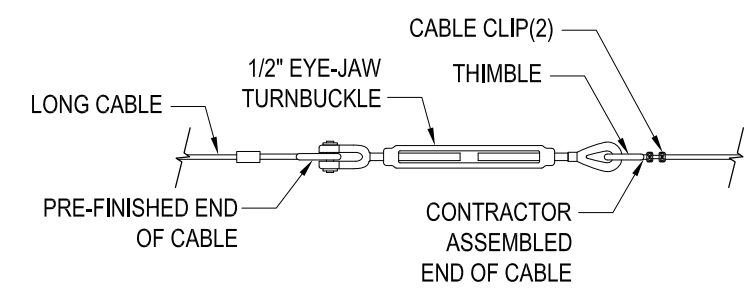

4 GROUND CABLE - LONG CABLE CONNECTION
Scale: NTS