

A Upright Post

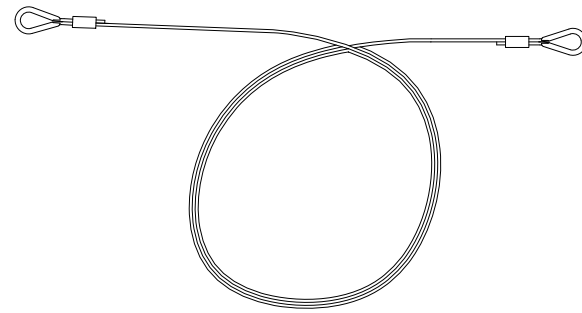

B Top Cable

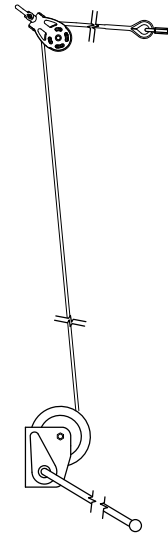

C Tension End Lifting Assembly

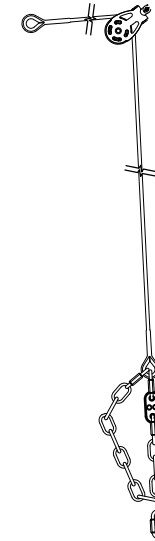

D Anchor End Lifting Assembly

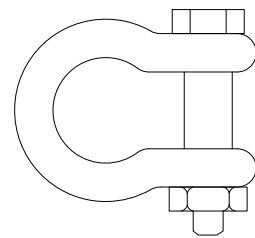

E Shackle

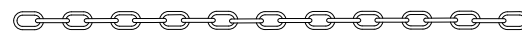

F Chain Door Weight

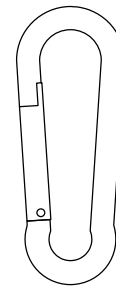

G Snap Hook

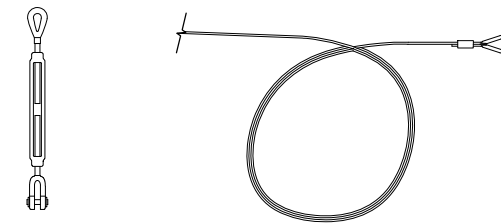
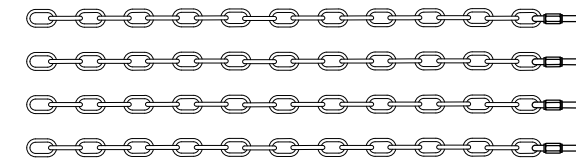

H Ground Cable Kit
NOT ALL ITEMS SHOWN

PARTS LIST

Sheet ID	QTY	DESCRIPTION
A	6	Upright Post
B	3	Top Cables (69'-6" L for 70' Cages <i>or</i> 54'-6" L for 55' Cages)
C	3	Tension End Lifting Assembly
D	3	Anchor End Lifting Assembly
E	6	3/8" Shackle
F	1	Chain Door Weight (36" L)
G	VARIES	Snap Hooks (140 for 70' Cages <i>or</i> 110 for 55' Cages)
H	1	Gound Cable Kit (See Attached Dwg Pkg.)
-	X	120# Cable Ties 8" (pack)
-	1	Premium Cage Net 70' L x 14' W x 14' H <i>or</i> Premium Cage Net 55' L x 14' W x 14' H

This is a standard Beacon Athletics product.
Any changes must be explicitly authorized and approved by Beacon Athletics.

REVISION #	DATE	BY

SCALE: SEE DWG
DRAWN BY: EH
DATE: 09/22/2017
MODEL: TFP55-1HST
PART #:105-100-475
DRAWING NO:
PS-1

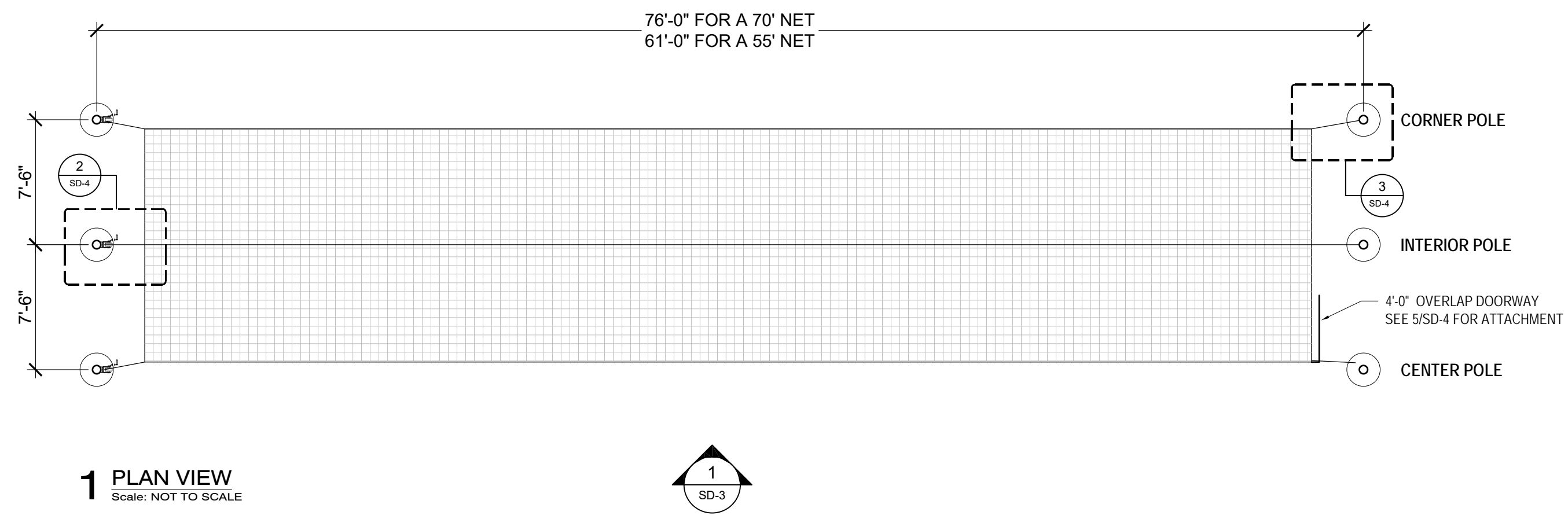

1 PLAN VIEW
 Scale: NOT TO SCALE

DRAWING TITLE: **TUFFframe™ PRO HOISTABLE OUTDOOR 55' BATTING CAGE - SINGLE LAYOUT**

CUSTOMER NAME: -
 PROJECT NAME: -
 PROJECT LOCATION: -

REVISION #	DATE	BY

SCALE:	SEE DWG
DRAWN BY:	EH
DATE:	09/22/2017
MODEL:	TFP55-1HST
PART #:	105-100-475
DRAWING NO:	SD-2

This is a standard Beacon Athletics product.
 Any changes must be explicitly authorized and approved by Beacon Athletics.

DRAWING TITLE: **TUFFframe™ PRO HOISTABLE OUTDOOR 55' BATTING CAGE - SINGLE ELEVATION & FOOTING DETAIL**

CUSTOMER NAME: -
PROJECT NAME: -
PROJECT LOCATION: -

REVISION #	BY	DATE

SCALE: SEE DWG
DRAWN BY: EH
DATE: 09/22/2017
MODEL: TFP55-1HST
PART #:105-100-475

DRAWING NO: **SD-3**

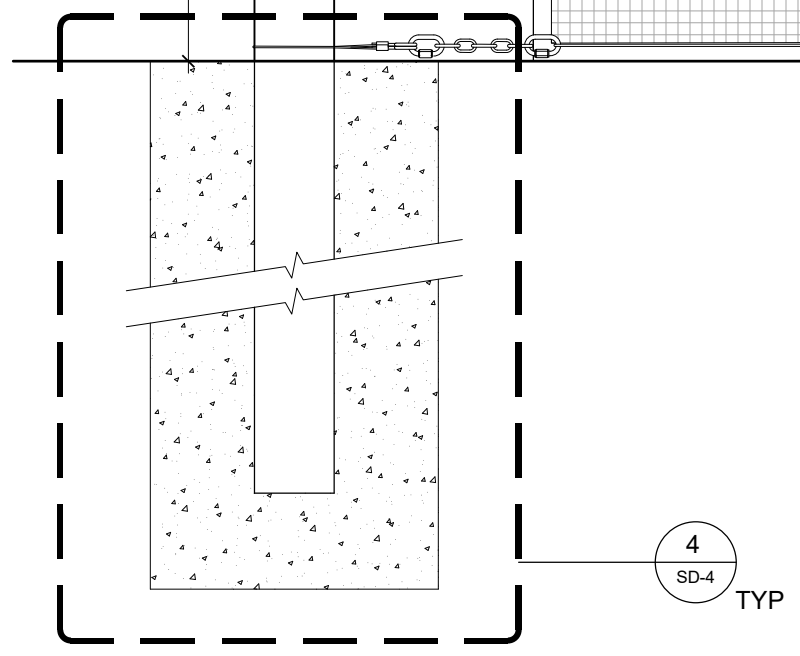
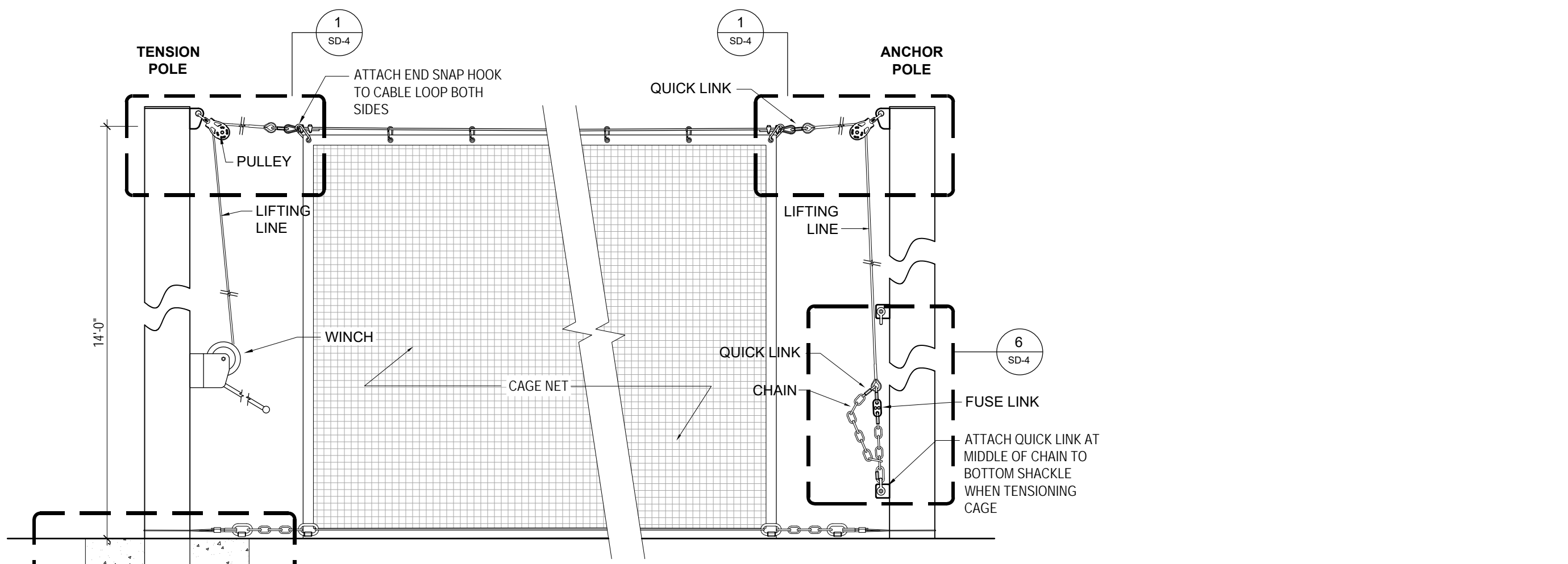

1 SIDE ELEVATION WHEN TENSIONED
Scale: 3/4" = 1'-0"

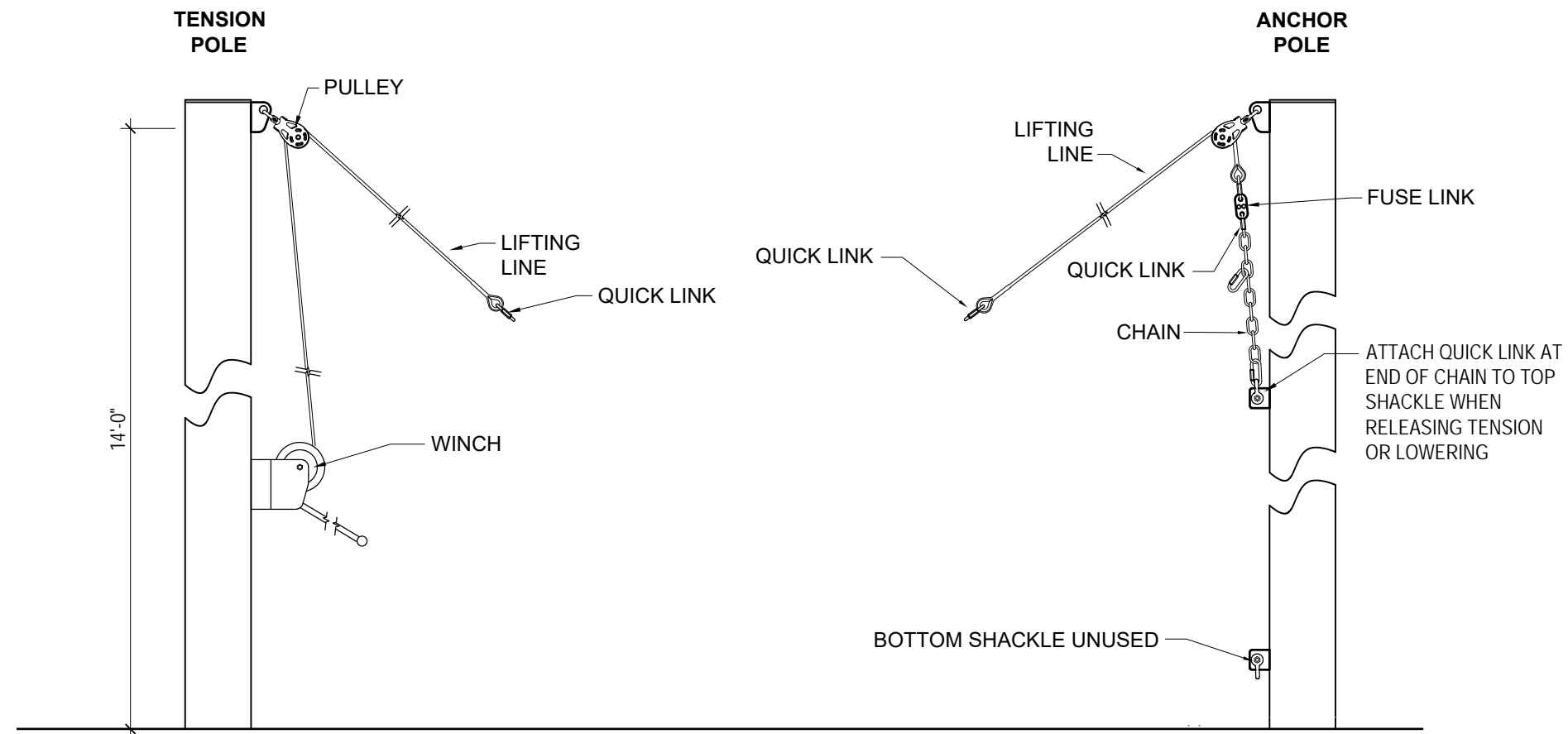

2 SIDE ELEVATION WHEN NOT TENSIONED
Scale: 3/4" = 1'-0"

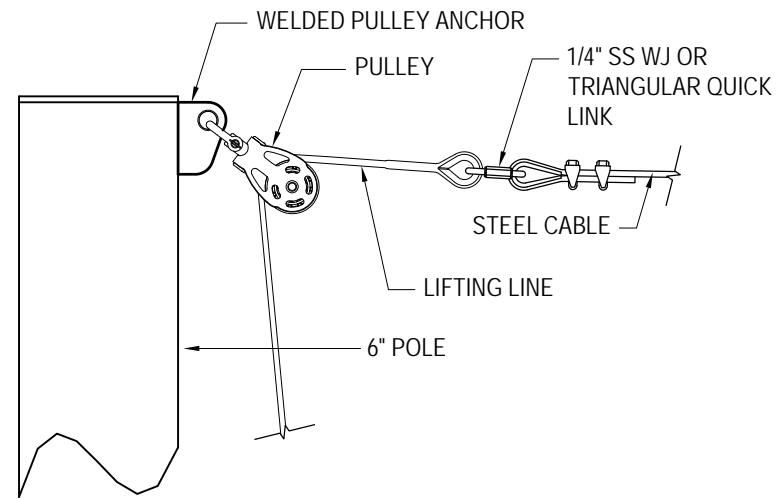

1 CABLE CONNECTION - SIDE VIEW
Scale: 1 1/2" = 1'-0"

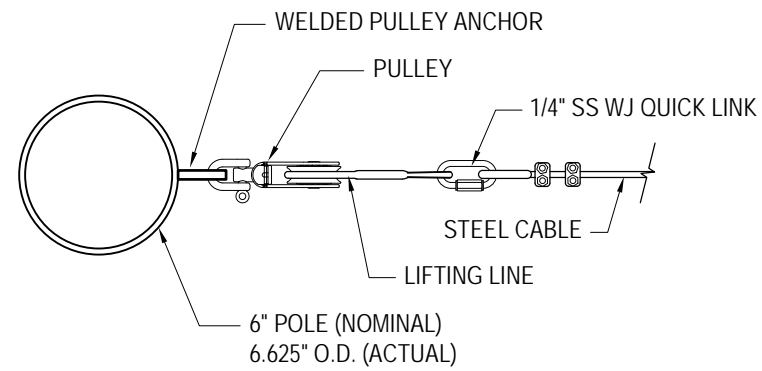

2 CORNER POLE CABLE - TOP VIEW
Scale: 1 1/2" = 1'-0"

3 NOT USED
Scale: 1 1/2" = 1'-0"

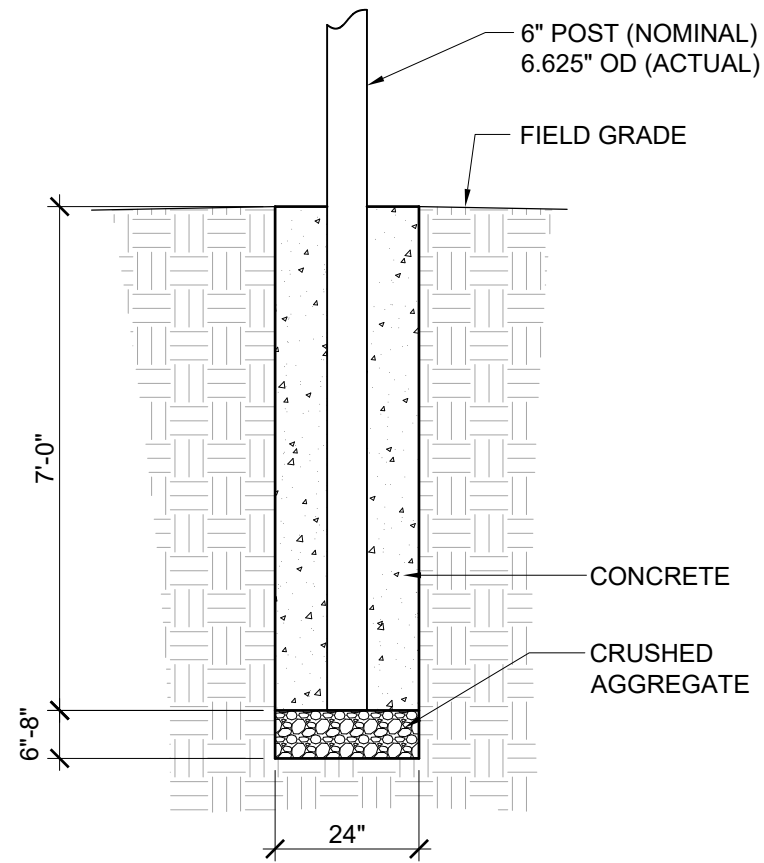

4 FOOTING DETAIL
Scale: 3/8" = 1'-0"

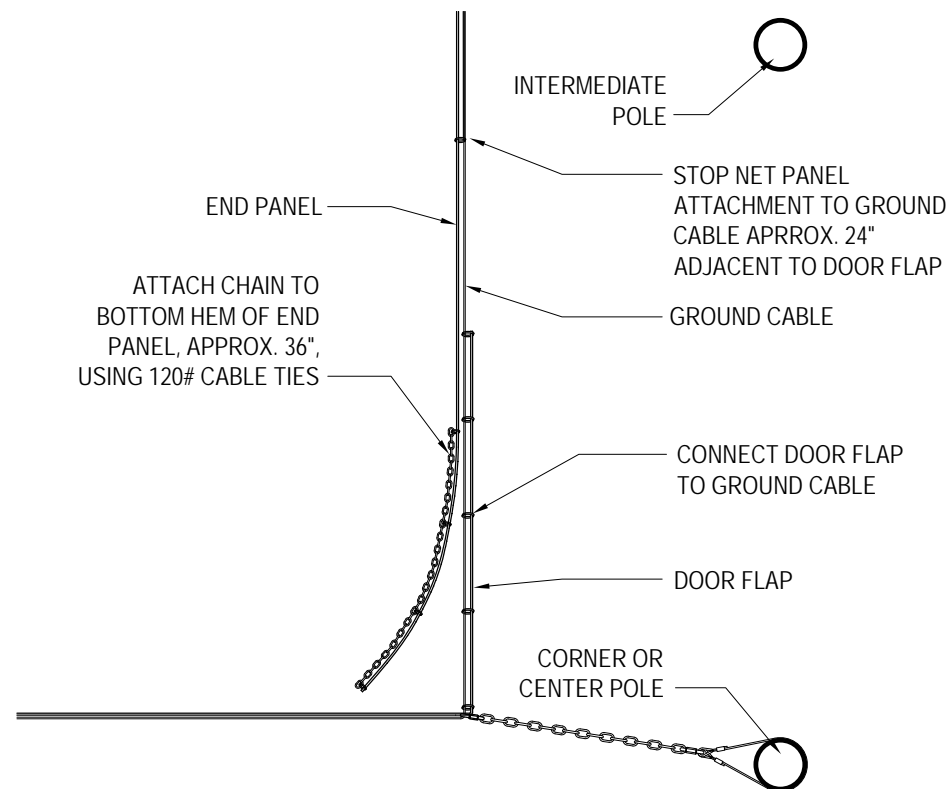

5 DOOR FLAP ATTACHMENT
Scale: Not to Scale

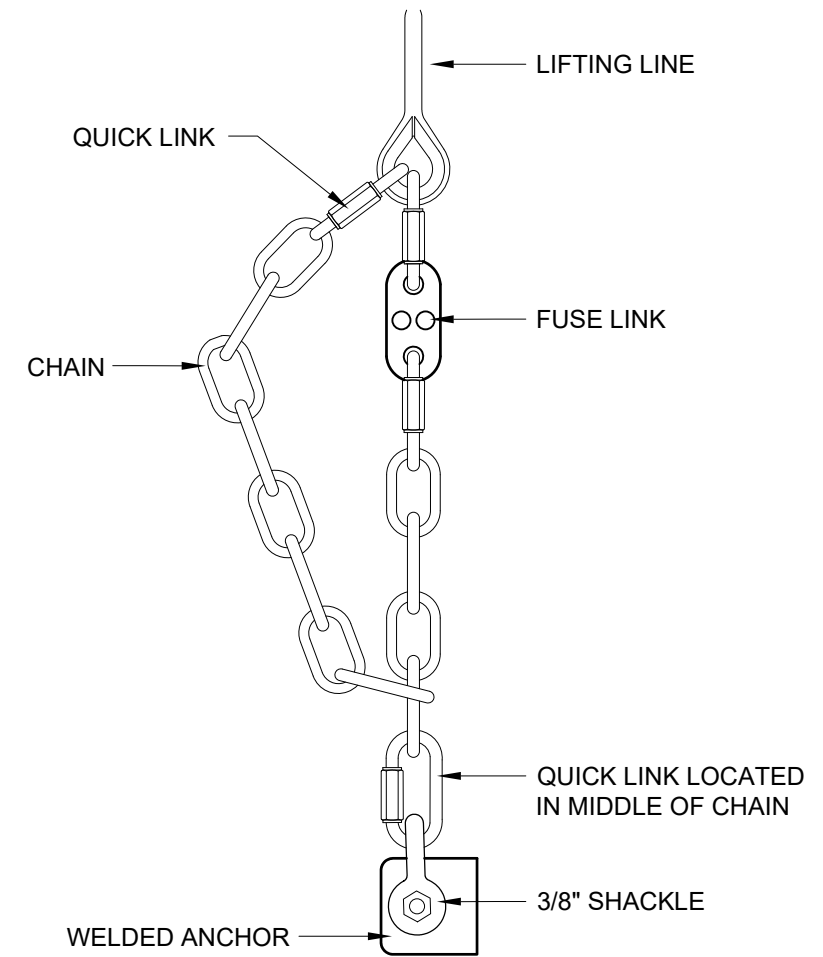

6 ANCHOR END CHAIN DETAIL
Scale: 3" = 1'-0"



© Copyright 2014 Beacon Athletics, Division of Rainbow Group, LLC.

DRAWING TITLE: **TUFFframe™ PRO HOISTABLE OUTDOOR 55' BATTING CAGE - SINGLE DETAILS**

CUSTOMER NAME: -
PROJECT NAME: -
PROJECT LOCATION: -

REVISION #	DATE	BY

SCALE:	SEE DWG
DRAWN BY:	EH
DATE:	09/22/2017
MODEL:	TFP55-1HST
PART #:	105-100-475
DRAWING NO:	SD-4

This is a standard Beacon Athletics product.
Any changes must be explicitly authorized and approved by Beacon Athletics.

PARTS LIST

DETAIL ID	QTY	DESCRIPTION
A	1	Eye-Jaw Turnbuckle
B	8	Wide Jaw Quick Links
C	4	Short Steel Cable
D	1	Long Cable Assembly (172'-0" for 70' Cage) (142'-0" for 55' Cage)
E	2	Cable Clamp
F	1	Thimble
G	4	24" Adjustment Chain
-	50	120# Cable Ties 8" (pack)

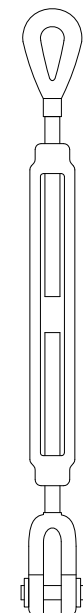

A Turnbuckle

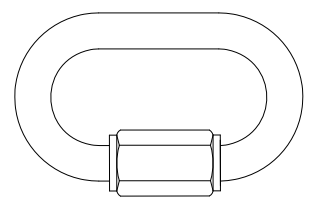

B Wide Jaw Quick Link



C Short Steel Cable

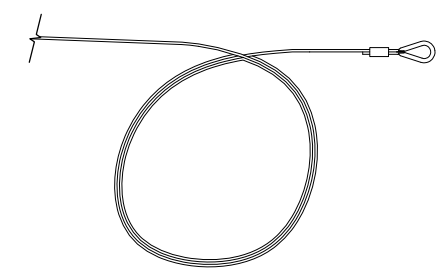

D Long Steel Cable

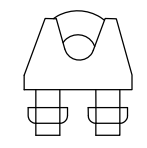

E Cable Clamp

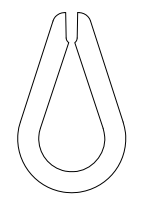

F Thimble

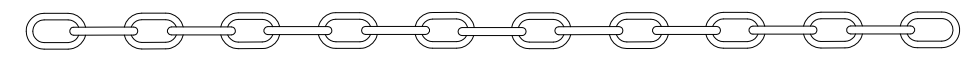

G ADJUSTMENT CHAIN

© Copyright 2014 Beacon Athletics,
Division of Rainbow Group, LLC.

DRAWING TITLE:
**GROUND CABLE KIT
PARTS LIST AND IDENTIFICATION**

CUSTOMER NAME: -
PROJECT NAME: -
PROJECT LOCATION: -

REVISION #	DATE	BY

SCALE:	NTS
DRAWN BY:	EH
DATE:	12/15/16
MODEL:	TFP55-1HST
PART #:	105-100-475
DRAWING NO:	GC-1

REVISION #	BY	DATE

SCALE:	NTS
DRAWN BY:	EH
DATE:	12/15/16
MODEL:	TFP55-1HST
PART #:	105-100-475
DRAWING NO:	GC-2



1 GROUND CABLES
 Scale: NTS

NOTE
 QUICK LINK LOCATION ON ADJUSTMENT CHAIN TO BE DETERMINED BY FINAL AS BUILT DIMENSIONS OF BATTING CAGE

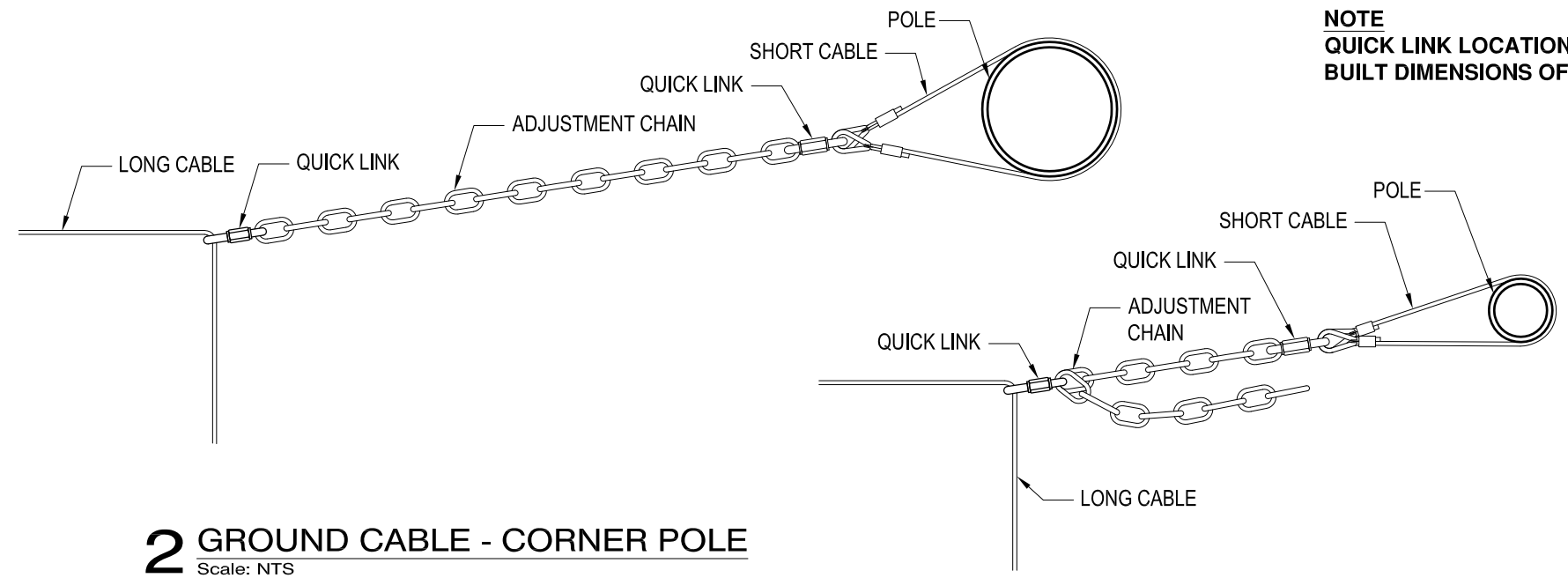

2 GROUND CABLE - CORNER POLE
 Scale: NTS

3 GROUND CABLE - CORNER POLE
 Scale: NTS

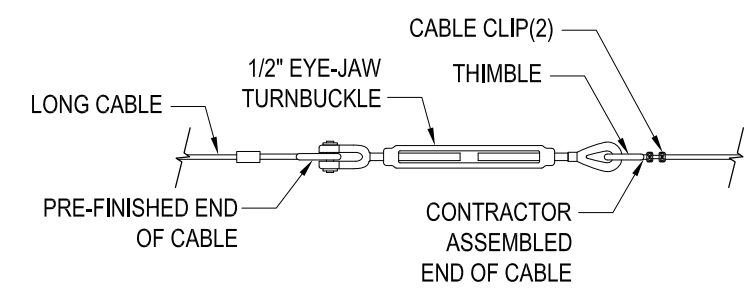

4 GROUND CABLE - LONG CABLE CONNECTION
 Scale: NTS