

A Upright Post

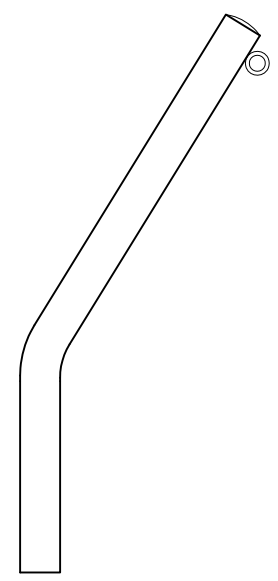

B Arch Unit w/ Eyebolt

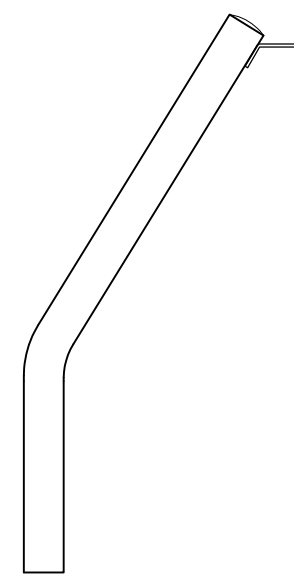

C Arch Unit w/ Anchor Bracket

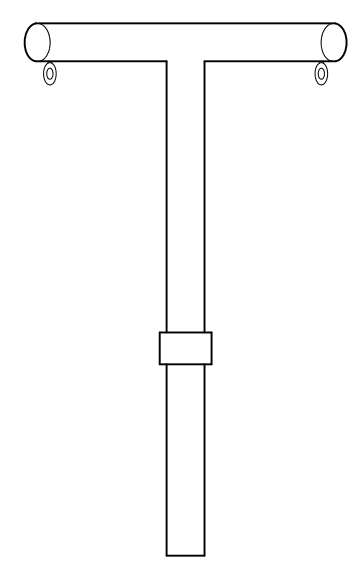

D "V" Unit w/ Eyebolts

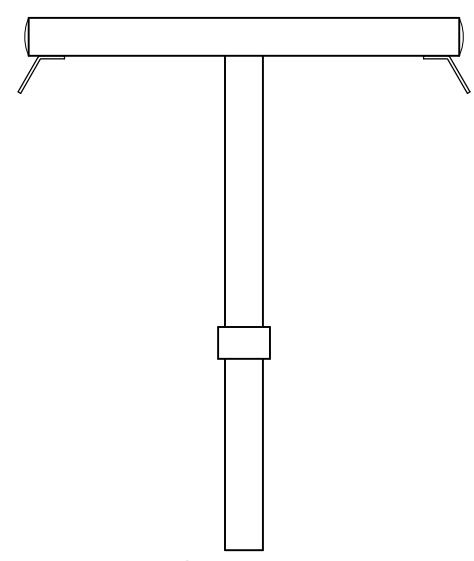

E "T" Unit w/ Anchor Brackets

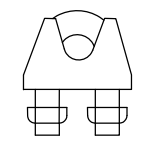

F Cable Clamp

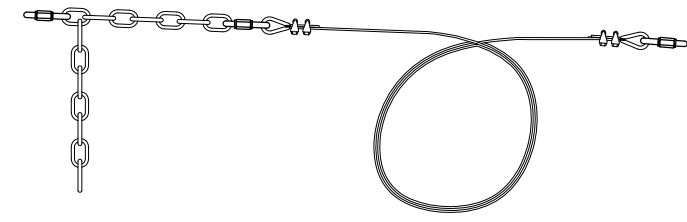

G Long Cable Assembly

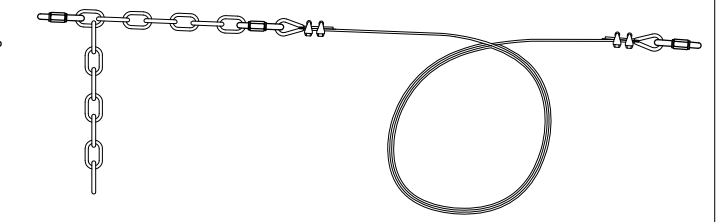

H Cross Cable Assembly

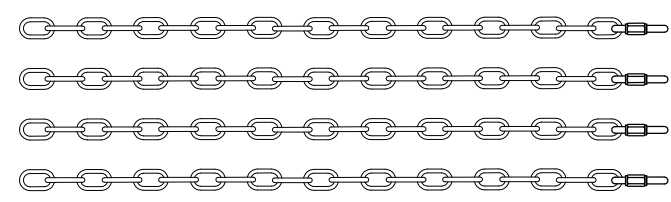

PARTS LIST

SHEET ID	QTY	DESCRIPTION
A	16	Upright Post (<i>may be provided by customer</i>)
B	4	Arch Unit w/ Eyebolt
C	4	Arch Unit w/ Anchor Bracket
D	4	"V" Unit w/ Eyebolts
E	4	"T" Unit w/ Anchor Brackets
F	12	3/16" Cable Clamp
G	9	Long Cable Assembly - 3/16" galv. steel cable, tensioning chain, wide jaw quick links
H	12	Cross Cable Assembly - 3/16" galv. steel cable, tensioning chain, wide jaw quick links
I	360	Bit Snap 1/4"
J	3	Ground Cable Kit - (See Attached Dwg Pkg.)
-	3	Premium Cage Net 55' L x 14' W x 12' H
-	16	Ground Sleeves & Caps (Optional)

BY	#
DATE	date
REVISION #	REV#

SCALE:	SEE DWG
DRAWN BY:	JP
DATE:	06/23/14
MODEL:	TFM55-3
PART #:	105-100-360
DRAWING NO:	PS-1

This is a standard Beacon Athletics product.
 Any changes must be explicitly authorized and approved by Beacon Athletics.

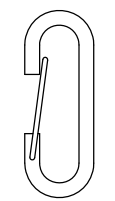

I Bit Snap

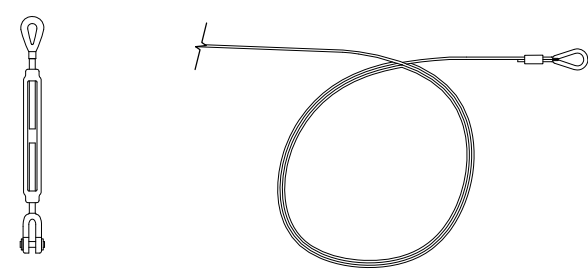

J Ground Cable Kit
 NOT ALL ITEMS SHOWN

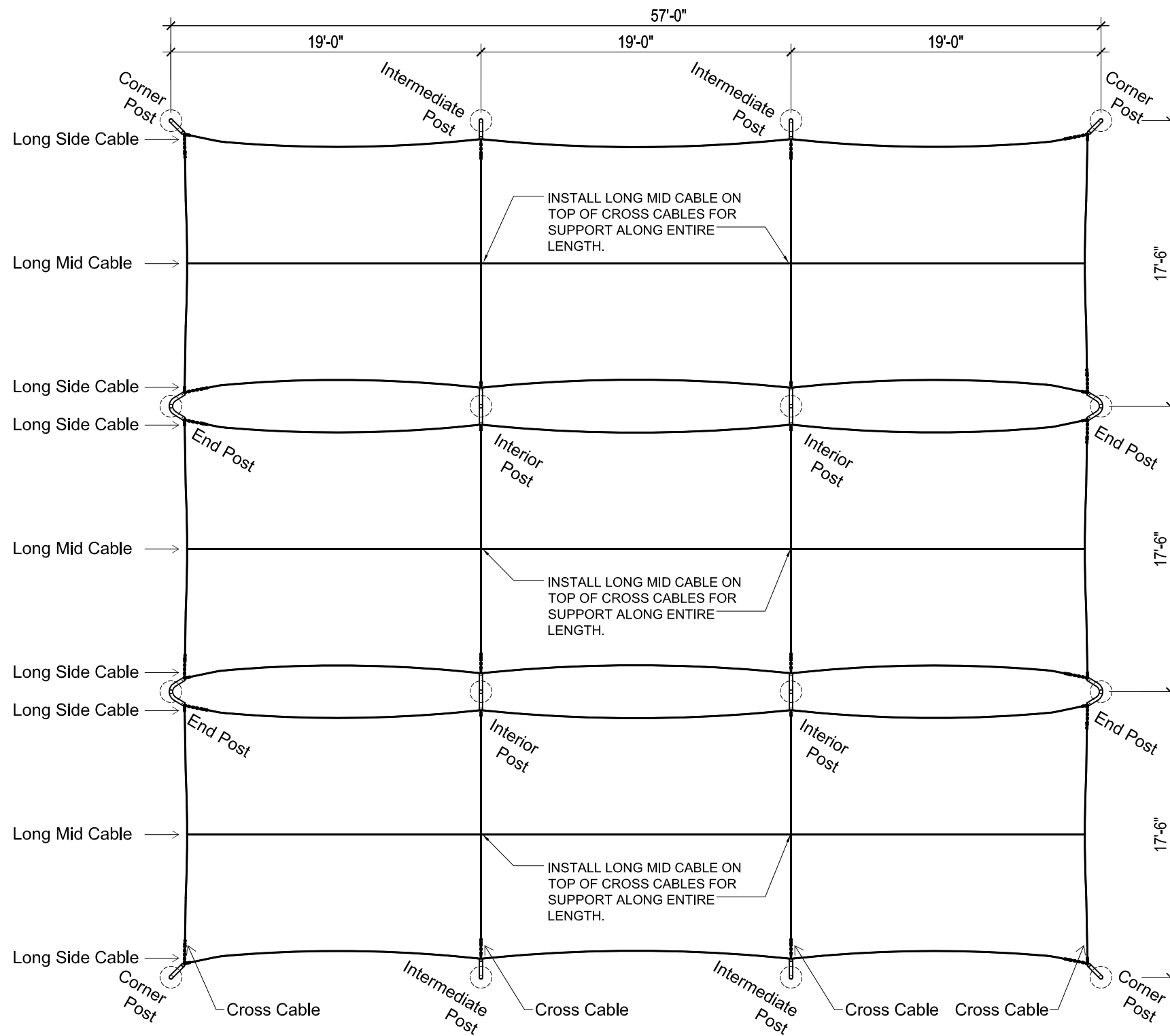

1 FOOTPRINT & CABLE LAYOUT
Scale: 1/8" = 1'-0"

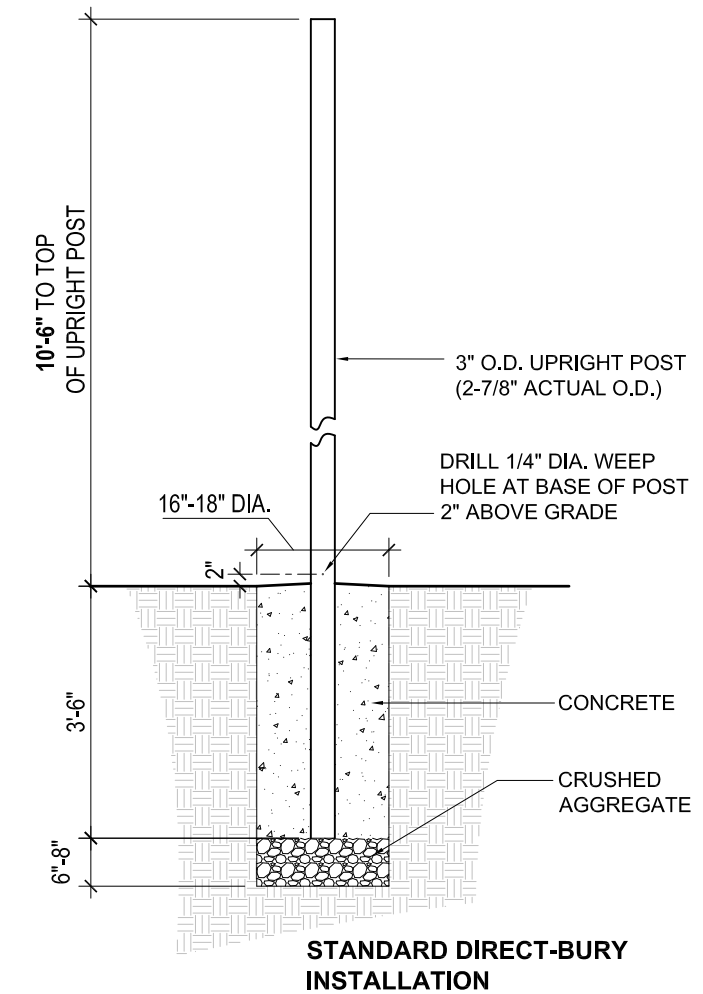

2 STANDARD FOOTING DETAIL
Scale: 3/8" = 1'-0"

DIRECT-BURY INSTALLATION:

1. Locate and excavate footings as noted in Details 1 and 2.
2. Fill bottom 6" - 8" of each footing with a coarse, compacted crushed aggregate.
3. Set one Upright Post directly onto aggregate in center of each footing and brace appropriately to hold in place. If the Upright Post has an internal burr on one end, place that end down into the footing. Height of Upright Post above grade should be 10'-6" as indicated on Detail 2.
4. Fill footings with 3,500 p.s.i. concrete mix and slope top surface away from each Upright Post to prevent water from pooling. Allow concrete to cure according to packaging instructions.
5. Once the concrete has cured, drill a 1/4" weep hole approximately 2" above grade on each Upright Post as indicated in Detail 2.

Note:
See last sheet for Detail 3, Optional Footing Detail, if applicable.



© Copyright 2014 Beacon Athletics, Division of Rainbow Group, LLC.

DRAWING TITLE:
TUFFframe™ MODULAR OUTDOOR 55' BATTING CAGE - TRIPLE FOOTPRINT & FOOTING DETAIL

CUSTOMER NAME: CUSTOMER NAME
PROJECT NAME: PROJECT NAME
PROJECT LOCATION: PROJECT LOCATION

REVISION #	REV#	DATE	BY	#

SCALE:	SEE DWG
DRAWN BY:	JP
DATE:	06/23/14
MODEL:	TFM55-3
PART #:	105-100-360
DRAWING NO:	SD-2



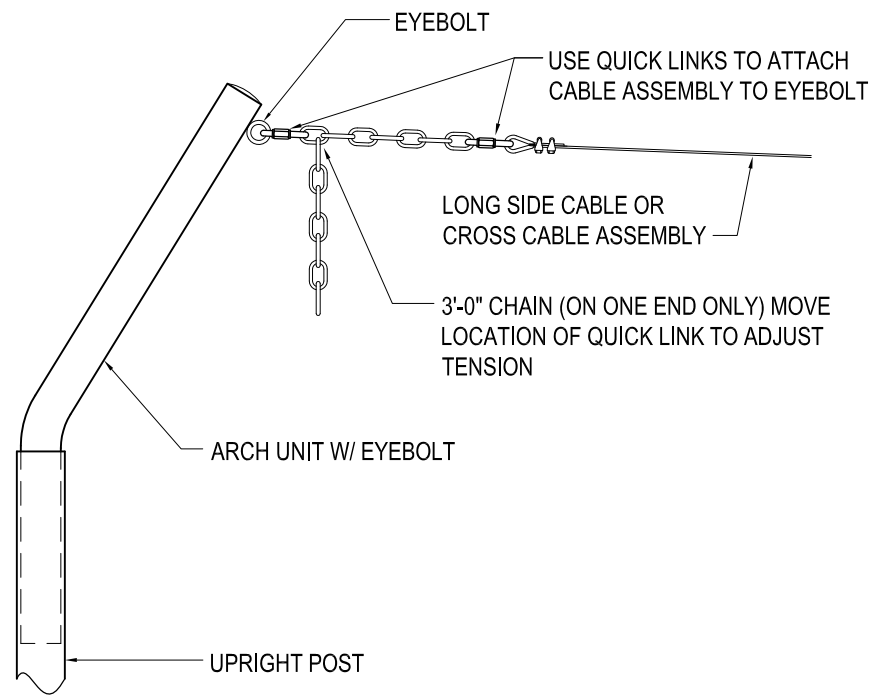

4 ATTACHMENT AT CORNER POST
Scale: NTS

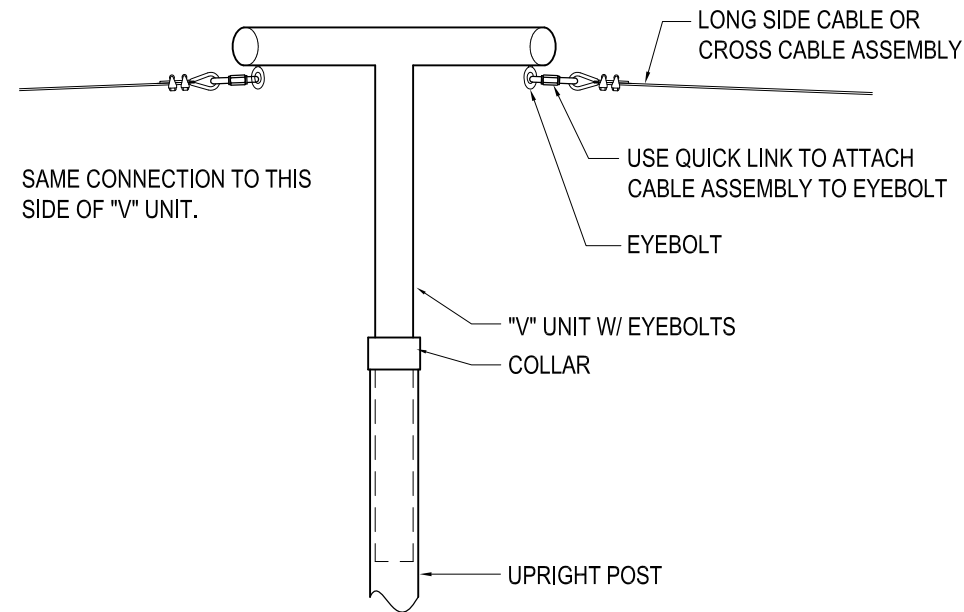

5 ATTACHMENT AT END POST
Scale: NTS

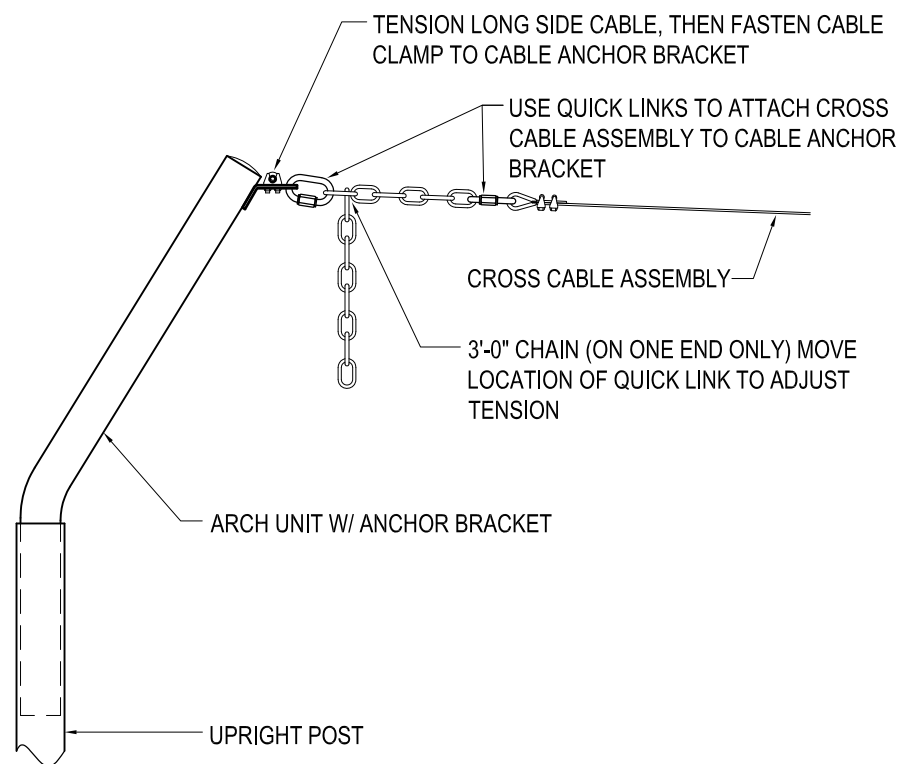

6 ATTACHMENT AT INTERMEDIATE POST
Scale: NTS

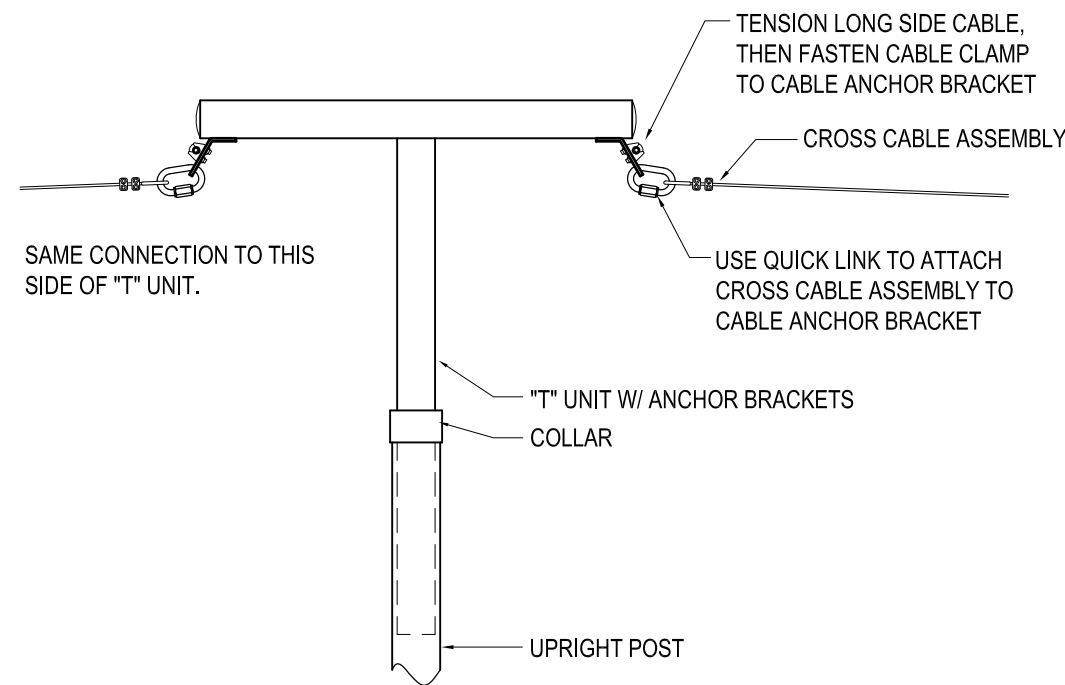

7 ATTACHMENT AT INTERIOR POST
Scale: NTS

OFFSET UNIT INSTALLATION:

1. After all Upright Posts are set in place, insert one Arch Unit w/Eyebolt into the top of each Upright Post at each corner post location, and one Arch Unit w/Anchor Bracket into each intermediate post location.
2. Insert one "V" Unit w/Eyebolts into each end post location, and one "T" Unit w/Anchor Brackets into each interior post location.
3. Rotate all offset units so the eyebolts and anchor brackets point towards the interior of the corresponding cage layouts - see Detail 1.

OVERHEAD CABLE INSTALLATION:

1. Begin by attaching and tensioning all Cross Cable Assemblies as shown in Details 4 through 7, as well as Detail 1. TENSION ONLY BY HAND! Do not apply mechanical tensioning devices.
2. Connect one end of each Long Side Cable (end without chain) to a corner post eyebolt. At each intermediate post location, attach the Long Side Cable to the top of the Anchor Bracket using a 3/16" Cable Clamp as shown in Detail 6, but DO NOT TIGHTEN the Cable Clamps.
3. Attach and tension the other end of the Long Side Cable (end with chain) to the opposite corner post eyebolt in the same manner as the Cross Cable Assemblies. TENSION ONLY BY HAND! Do not apply mechanical tensioning devices.
4. Repeat Steps 2 and 3 for the Long Side Cables that connect to the end and interior post locations. See Detail 1.
5. Once all Long Side Cables are tensioned, tighten Cable Clamps at all intermediate and interior post locations.
6. Connect Long Mid Cable at the center of one end Cross Cable. Lay the Long Mid Cable ON TOP of the Cross Cables as noted on Detail 1 and connect to the other end Cross Cable. Apply light tension only. Repeat this step for each cage area (there is one Long Mid Cable per cage).



© Copyright 2014 Beacon Athletics, Division of Rainbow Group, LLC.

DRAWING TITLE: **TUFFframe™ MODULAR OUTDOOR 55' BATTING CAGE - TRIPLE TOP CABLE ATTACHMENT**

CUSTOMER NAME: CUSTOMER NAME
PROJECT NAME: PROJECT NAME
PROJECT LOCATION: PROJECT LOCATION

REVISION #	REV#	DATE	date	BY	#

SCALE:	SEE DWG
DRAWN BY:	JP
DATE:	06/23/14
MODEL:	TFM55-3
PART #:	105-100-360
DRAWING NO:	SD-3



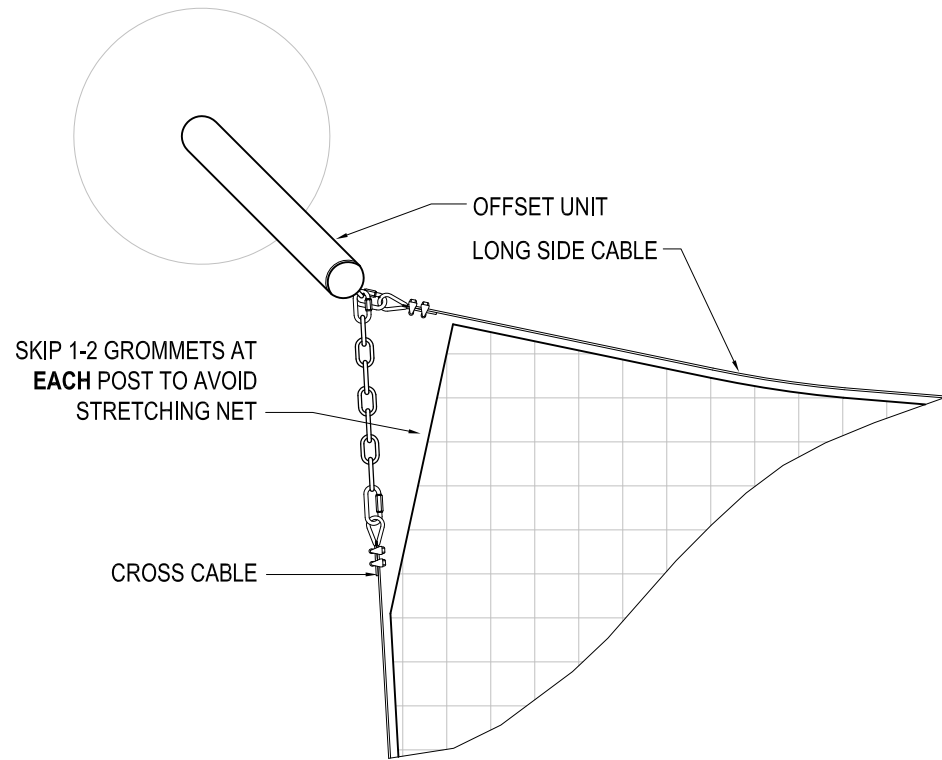

8 NET ATTACHMENT DETAIL

Scale: NTS

NET INSTALLATION:

1. Stretch one net out on the ground inside a cage to orient it correctly with the door flaps placed in the desired locations and top perimeter hem sitting on top.
2. Begin attaching the net at one end Cross Cable. Center the net on the Cross Cable from side-to-side so that the Long Mid Cable aligns with the center hem on the roof of the net. Connect the net to the end Cross Cable with Bit Snaps provided. Connect only through the grommets on the net - do not clip directly to the mesh of the net. The net will not reach all the way to the offset units - this is normal. Do not try to stretch the corners of the net all the way to the eyebolts - this may cause damage to the net.
3. Once the net is attached to the end Cross Cable, begin connecting along one Long Side Cable. You will have to skip the first one or two grommets along the side hem until it easily reaches the Long Side Cable (see Detail 8). This is normal. Again, do not try to stretch the net excessively to reach the cable.
4. This same process will need to be repeated at each intermediate post location as the net will not be able to stretch all the way to the eyebolts. The 2-4 grommets closest to the intermediate posts will need to be left free of the cable.
5. Continue connecting the net until you reach the end of the first Long Side Cable, leaving the last 3-4 feet free - this will be connected later as needed.
6. Repeat this process for the Long Mid Cable and second Long Side Cable. Please note that you will not have to skip any grommets for the Long Mid Cable - every grommet should be used.
7. Once the net is attached to all Long Cable Assemblies, the end can then be clipped to the remaining end Cross Cable. Again, the net should be centered side-to-side and will not reach all the way to the eyebolts.
8. After the end of the net is secured, go back to check the last 3-4 feet of each Long Side Cable that was left free. Connect any remaining grommets as able, remembering not to stretch the net excessively (some grommets may go unused).
9. Repeat this process for the remaining net(s) in each cage area.



© Copyright 2014 Beacon Athletics, Division of Rainbow Group, LLC.

DRAWING TITLE:
TUFFframe™ MODULAR OUTDOOR 55' BATTING CAGE - TRIPLE NET AND GROUND CABLE ATTACHMENT

CUSTOMER NAME: CUSTOMER NAME
 PROJECT NAME: PROJECT NAME
 PROJECT LOCATION: PROJECT LOCATION

REVISION #	DATE	BY
REV#	date	#

SCALE:	SEE DWG
DRAWN BY:	JP
DATE:	06/23/14
MODEL:	TFM55-3
PART #:	105-100-360
DRAWING NO:	SD-4



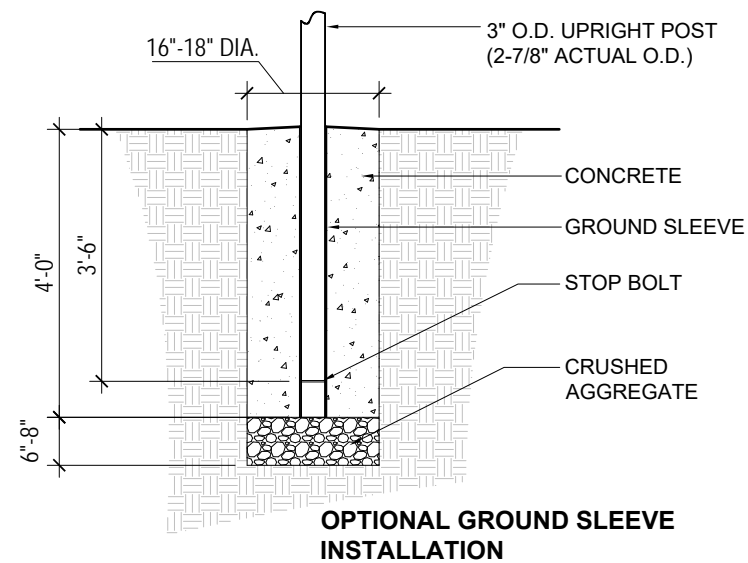

**OPTIONAL GROUND SLEEVE
INSTALLATION**

3 OPTIONAL FOOTING DETAIL

Scale: 3/8" = 1'-0"

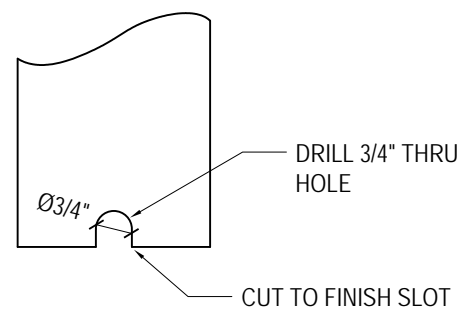

NOTCH POSTS W/ SOFT TOSS
ATTACHMENT AND LOCK ONTO
CROSS BOLT TO PREVENT POST
ROTATION DURING SOFT TOSS
CABLE TENSIONING

GROUND SLEEVE INSTALLATION (OPTIONAL):

1. Locate and excavate footings as noted in Details 1 and 3.
2. Fill bottom 6" - 8" of each footing with a coarse, compacted crushed aggregate.
3. Set one Ground Sleeve directly onto aggregate in center of each footing (with the stop bolt at the bottom) and brace appropriately to hold in place.
4. Fill footings with 3,500 p.s.i. concrete mix and slope top surface away from each Ground Sleeve to prevent water from pooling. Allow concrete to cure according to packaging instructions.
5. Once the concrete has cured, insert one Upright Post into each Ground Sleeve until it comes to rest on the stop bolt. If the Upright Post has an internal burr on one end, place that end down into the sleeve. The height of the Upright Post above grade should be 10'-6".

IMPORTANT: IF FREEZING TEMPERATURES OCCUR IN YOUR LOCATION, DO NOT BLOCK BOTTOM OPENING OF UPRIGHT POSTS OR GROUND SLEEVES WITH CONCRETE. DAMAGE MAY OCCUR.



© Copyright 2014 Beacon Athletics,
Division of Rainbow Group, LLC.

DRAWING TITLE:
**TUFFframe™ MODULAR OUTDOOR 55' BATTING CAGE - TRIPLE
NET AND GROUND CABLE ATTACHMENT**

CUSTOMER NAME:
PROJECT NAME:
PROJECT LOCATION:

REVISION #	REV#	DATE	BY	#

SCALE:	SEE DWG
DRAWN BY:	JP
DATE:	06/23/14
MODEL:	TFM55-3
PART #:	105-100-360
DRAWING NO.:	SD-5

This is a standard Beacon Athletics product.
Any changes must be explicitly authorized and approved by Beacon Athletics.

PARTS LIST

DETAIL ID	QTY	DESCRIPTION
A	1	Eye-Jaw Turnbuckle
B	8	Wide Jaw Quick Links
C	4	Short Steel Cable
D	1	Long Cable Assembly (172'-0" for 70' Cage) (142'-0" for 55' Cage)
E	2	Cable Clamp
F	1	Thimble
G	4	24" Adjustment Chain
-	50	120# Cable Ties 8" (pack)

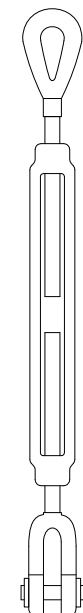

A Turnbuckle

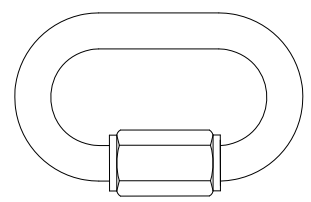

B Wide Jaw Quick Link



C Short Steel Cable

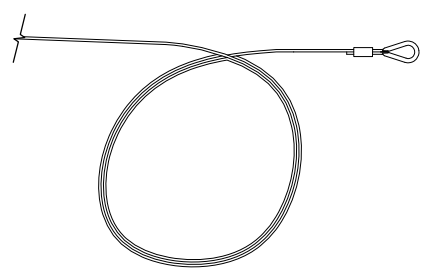

D Long Steel Cable

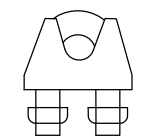

E Cable Clamp

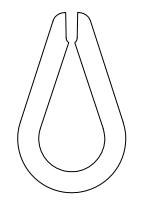

F Thimble

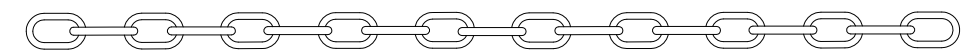

G ADJUSTMENT CHAIN

© Copyright 2014 Beacon Athletics,
Division of Rainbow Group, LLC.

DRAWING TITLE:
**GROUND CABLE KIT
PARTS LIST AND IDENTIFICATION**

CUSTOMER NAME: -
PROJECT NAME: -
PROJECT LOCATION: -

REVISION #	DATE	BY

SCALE:	NTS
DRAWN BY:	EH
DATE:	12/15/16
MODEL:	TFM55-3
PART #:	105-100-360
DRAWING NO:	

GC-1

REVISION #	BY	DATE

SCALE:	NTS
DRAWN BY:	EH
DATE:	12/15/16
MODEL:	TFM55-3
PART #:	105-100-360
DRAWING NO:	GC-2

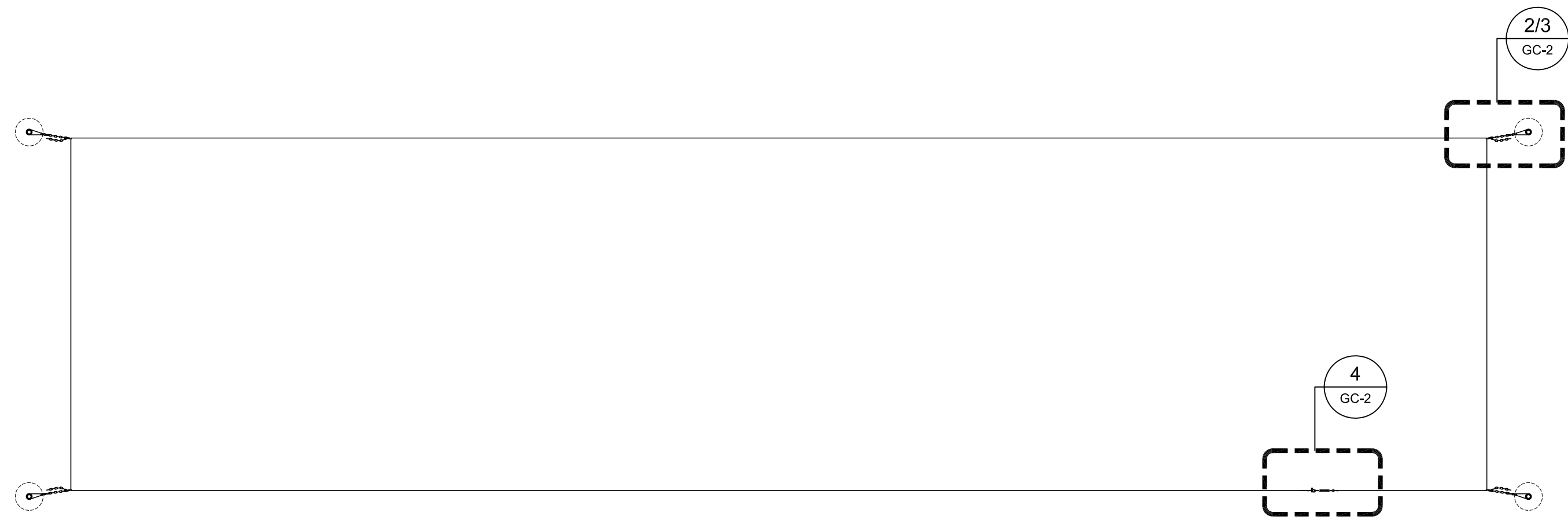

1 GROUND CABLES
Scale: NTS

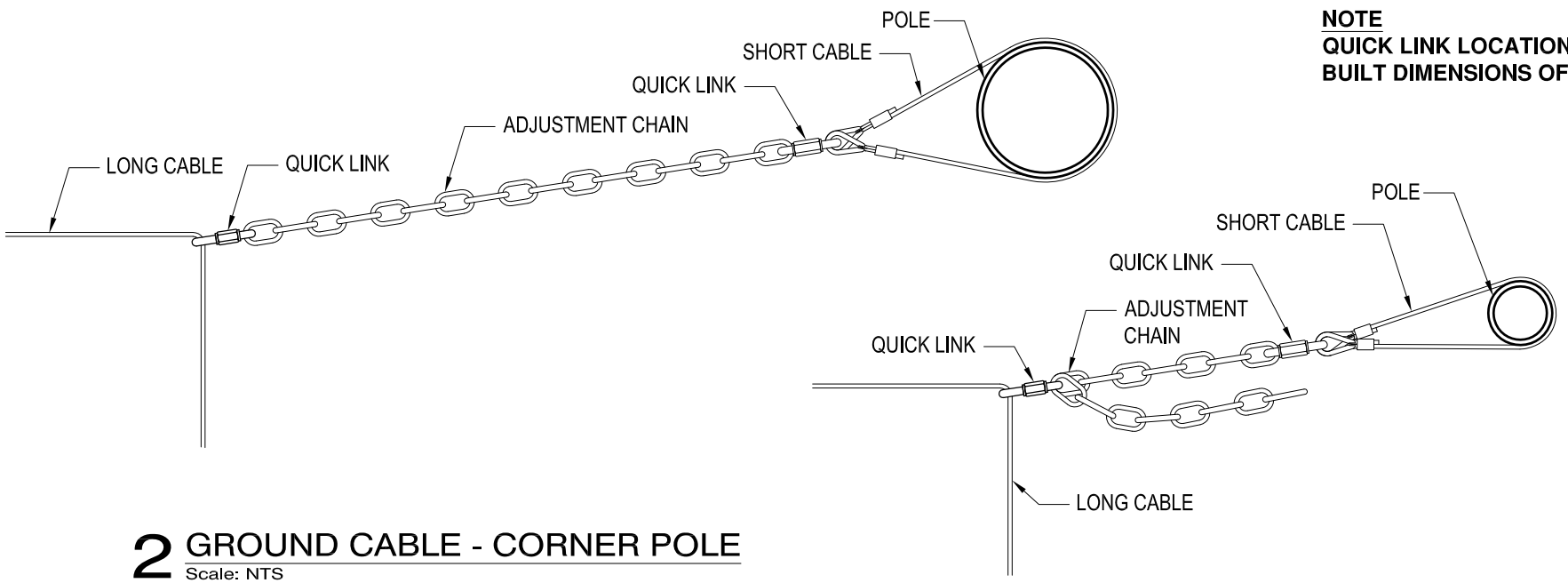

2 GROUND CABLE - CORNER POLE
Scale: NTS

3 GROUND CABLE - CORNER POLE
Scale: NTS

NOTE
QUICK LINK LOCATION ON ADJUSTMENT CHAIN TO BE DETERMINED BY FINAL AS BUILT DIMENSIONS OF BATTING CAGE

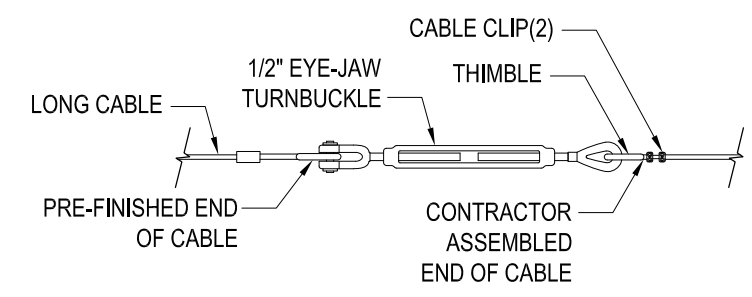

4 GROUND CABLE - LONG CABLE CONNECTION
Scale: NTS