

PLAN VIEW

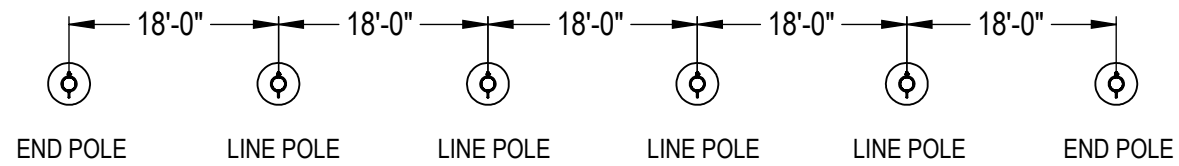

ELEVATION VIEW

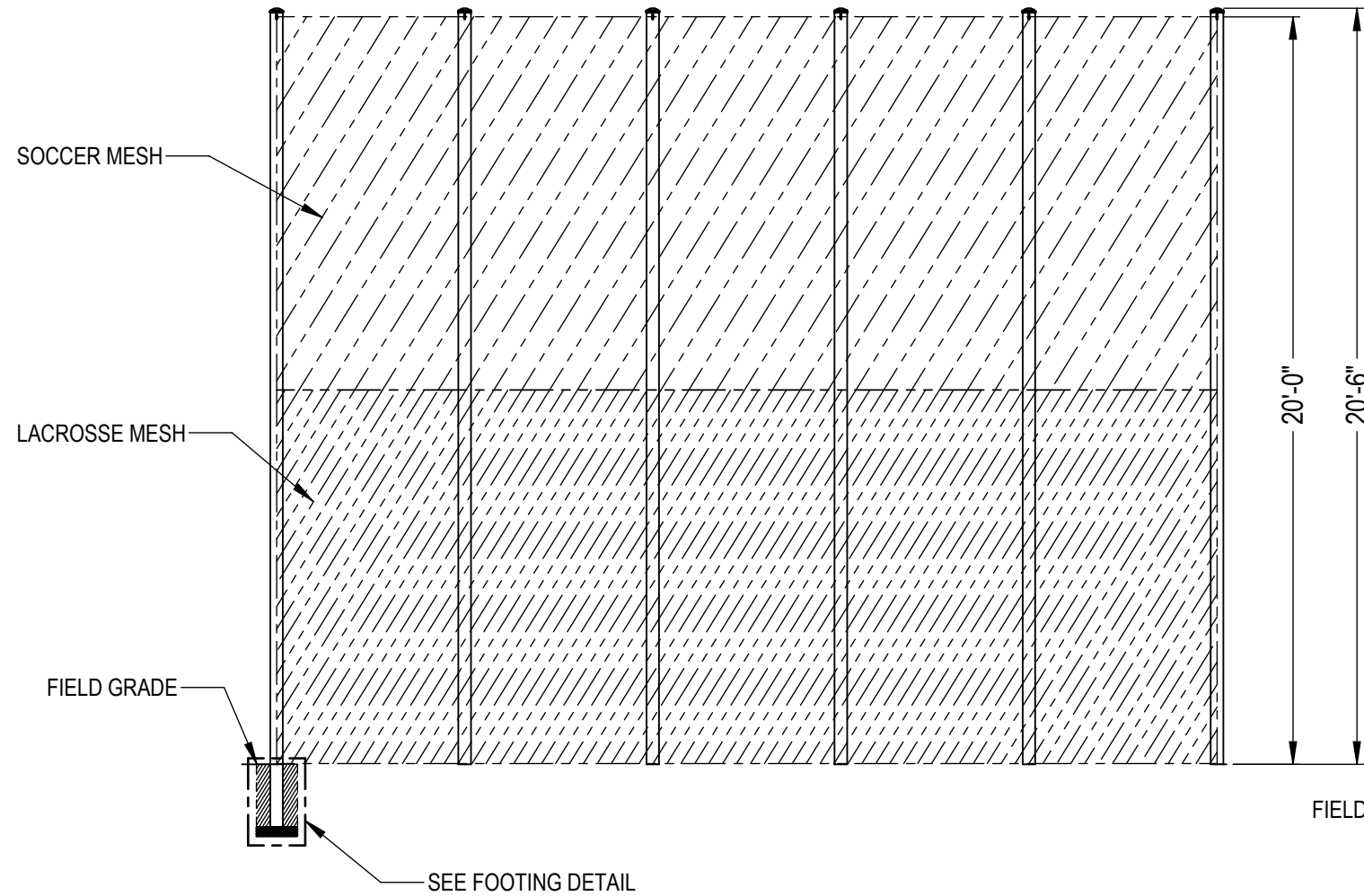

FOOTING DETAIL

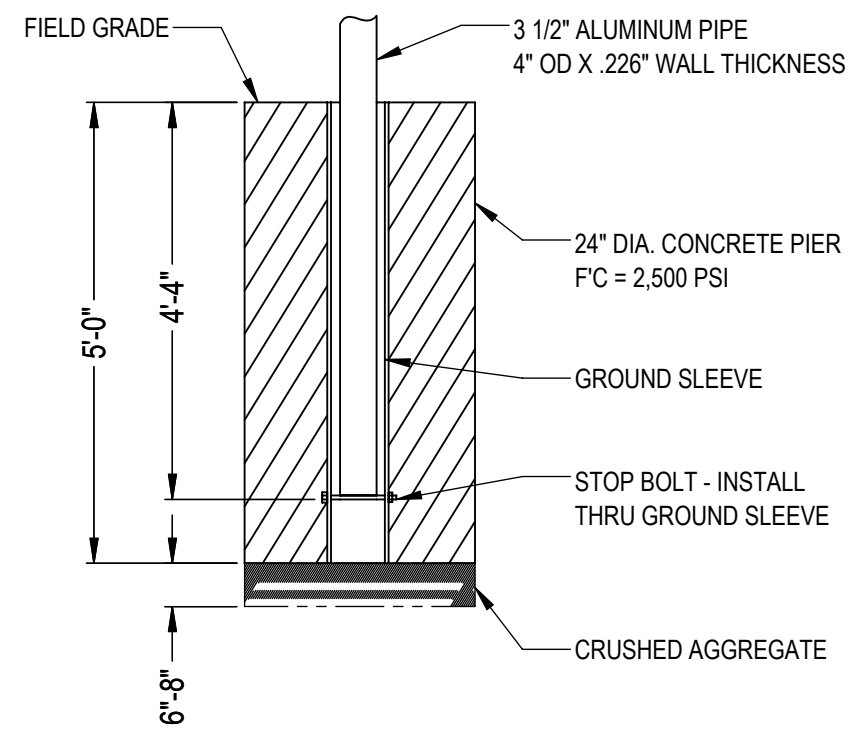

FRONT VIEW

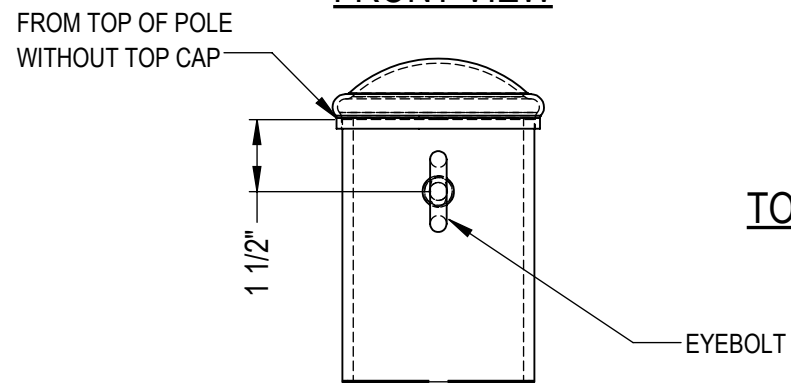

TOP OF POLE DETAIL

TOP VIEW

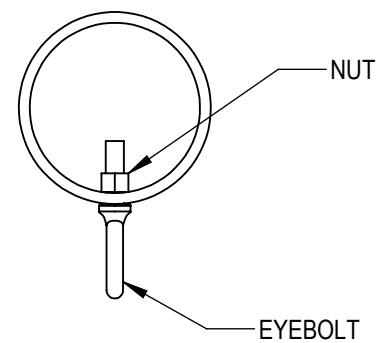

REVISION #	DATE	BY
1	02/21/2024	JD

DRAWN BY: JD
DATE: 02/21/2024
MODEL NO:
BNC-2090

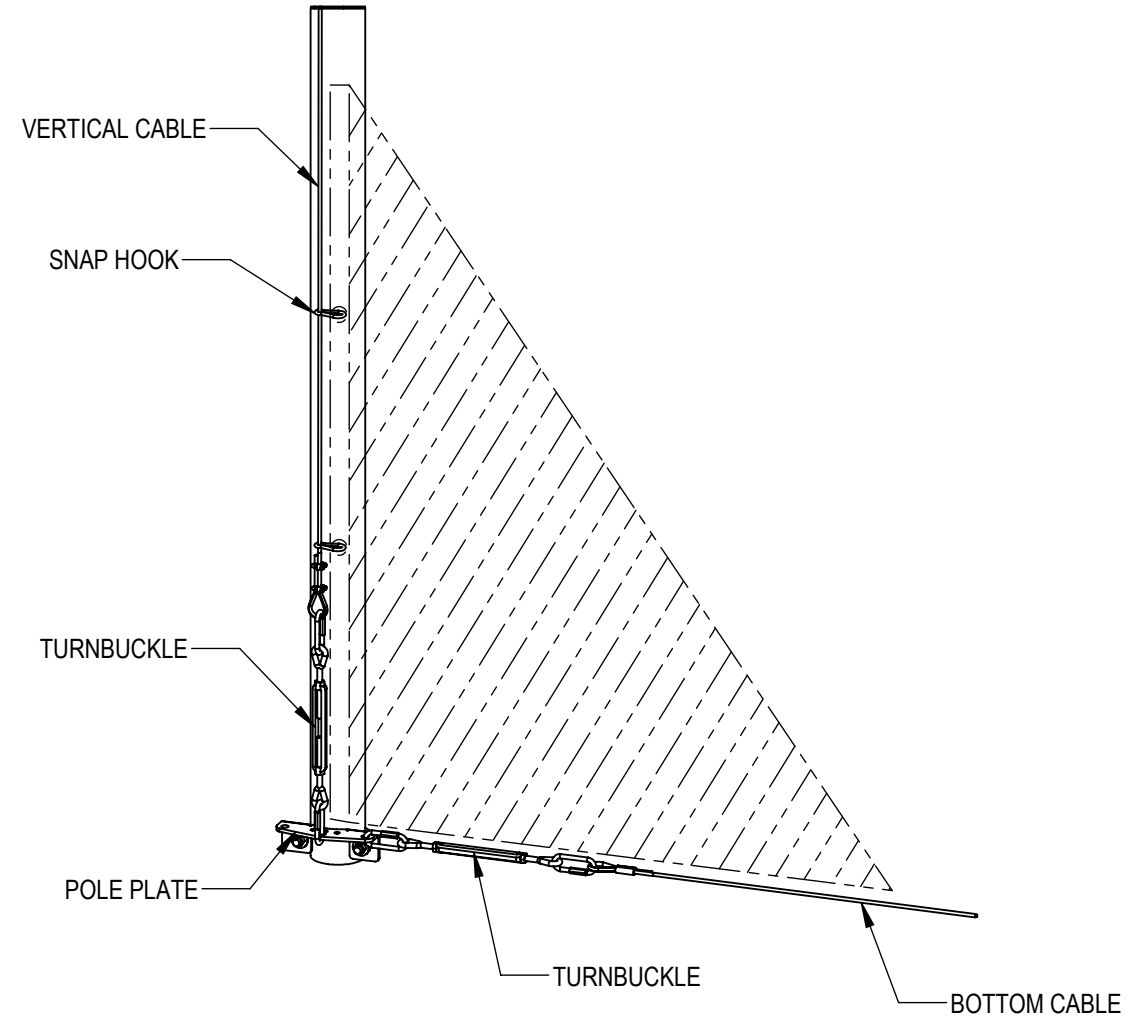
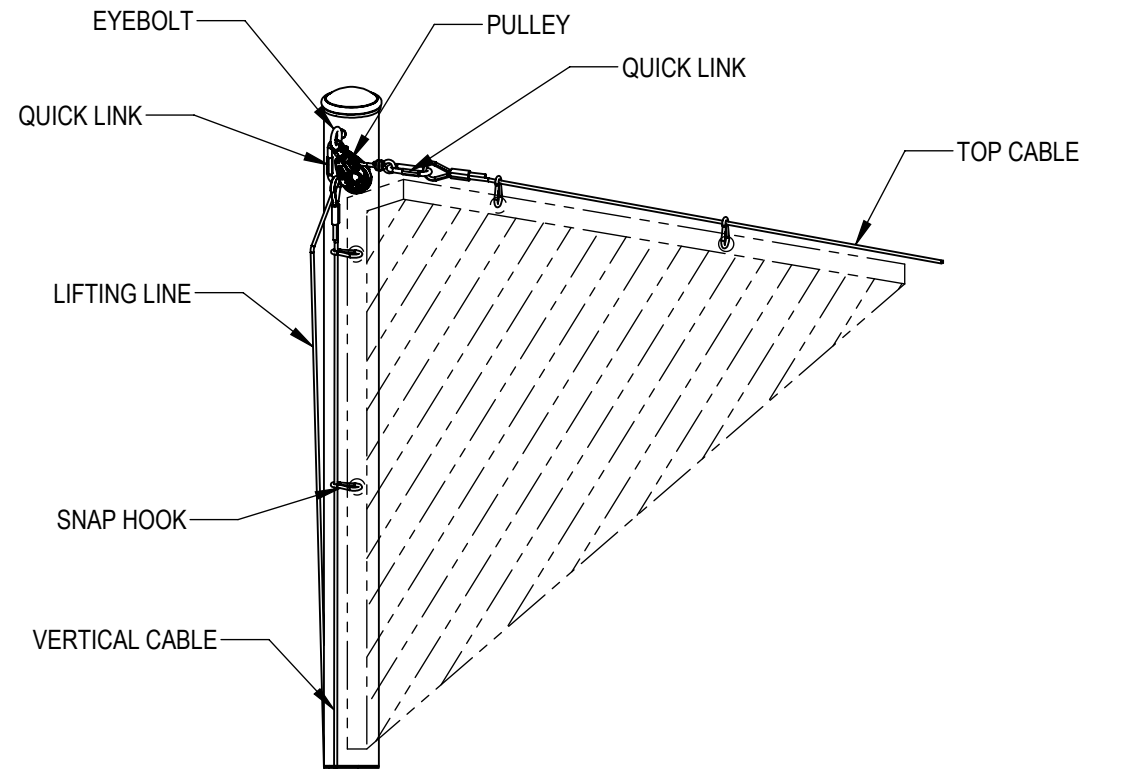

LEFT SIDE END POLE CONNECTIONS

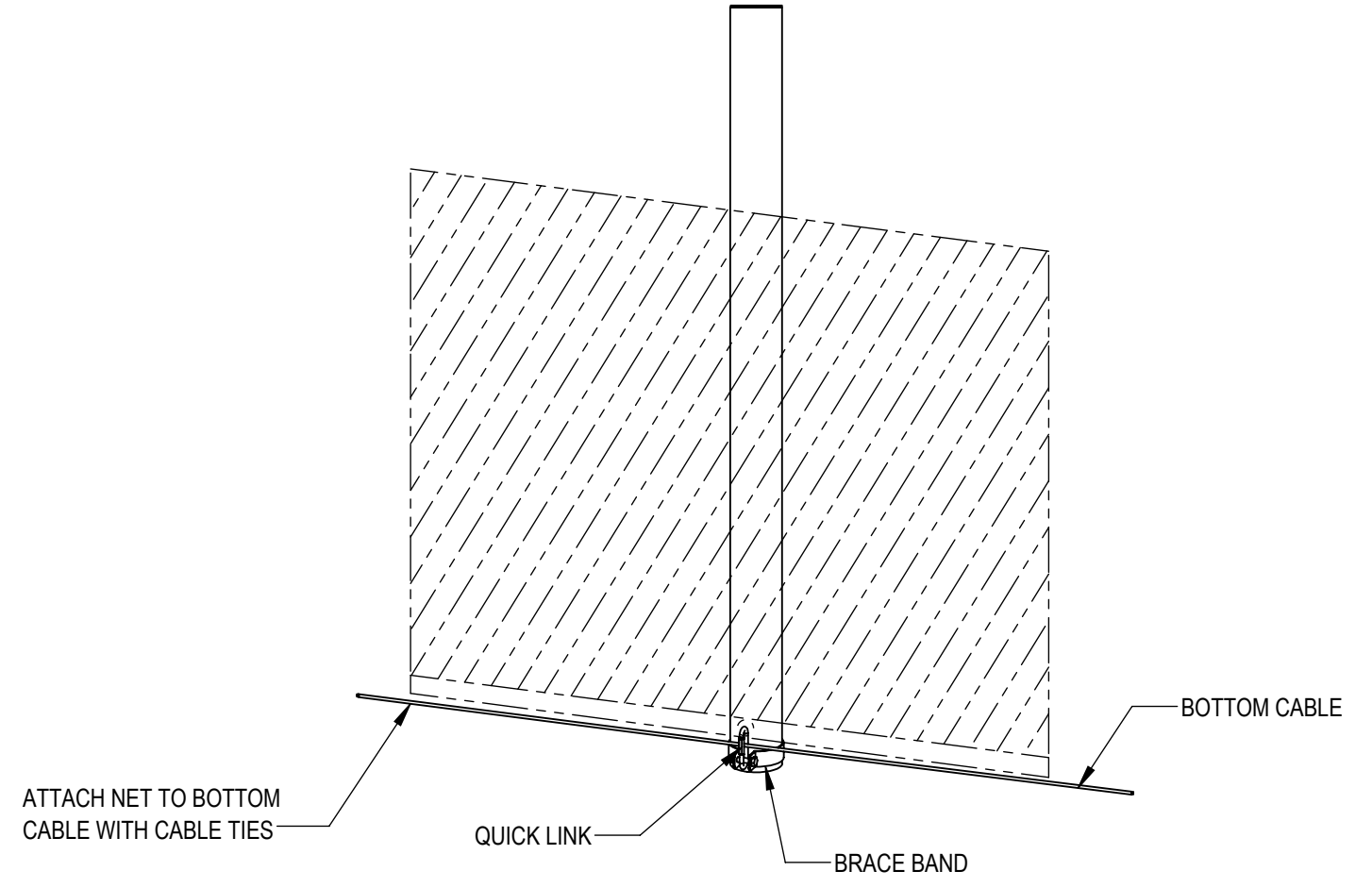
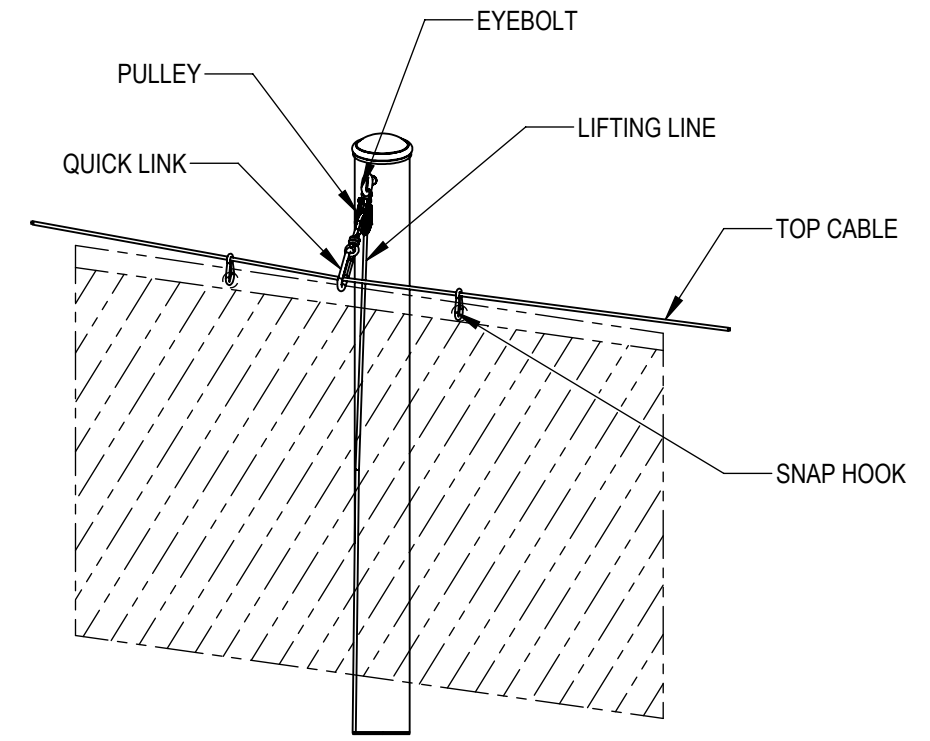

LINE POLE CONNECTIONS

REVISION #	BY	DATE
1	JD	02/21/2024

DIMETRIC VIEW

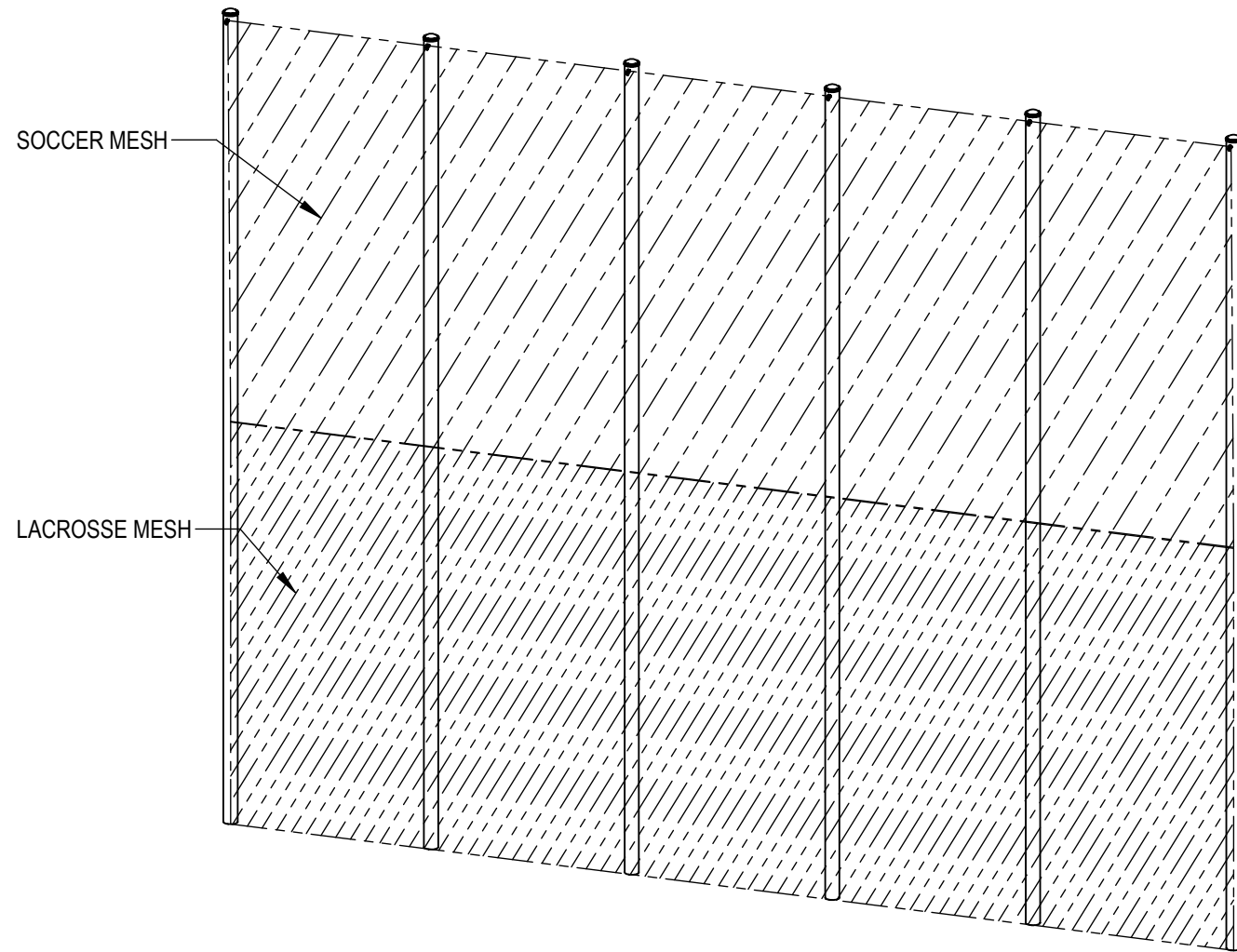

PARTS LIST

DESCRIPTION
SUPPORT POLES - 4" OD X 25'-0"
GROUND SLEEVE WITH STOP BOLT
STEEL HORIZONTAL CABLE
STEEL VERTICAL CABLE
POLY BRAIDED ROPE (LIFTING LINE)
EYE EYE TURNBUCKLE
ROPE CLEAT
1/4" - 20 SCREWS FOR ROPE CLEAT
CONNECTION PLATE W/U-BOLT
BRACE BANDS
QUICK LINK
SNAP HOOK
EYEBOLT
NUT
POLE TOP CAP
THIMBLES
ROPE CLIPS
LINE POLE PULLEY
END POLE PULLEY
#120 CABLE TIES
DRILL & TAP KIT FOR ROPE CLEAT

POLE PREPARATION

1. THE POLES WILL NEED (2) OPPOSITE SIDE NOTCHES GROUNDED IN THEIR BOTTOM EDGE TO LOCK THE POLE AGAINST ROTATION ONCE IT IS SET INTO THE GROUND SLEEVE. THE GROUND SLEEVES HAVE CROSS BOLTS (1/2" DIA.) AND THE NOTCHES SHOULD BE SIZED TO FIT OVER THESE BOLTS. THE POLE ORIENTATION ONCE INSTALLED MUST BE SUCH THAT THE EYE BOLT IS ON THE FIELD SIDE.
2. BEFORE FINAL INSTALLATION OF THE POLES THE PULLEYS AND LIFTING LINES SHOULD BE CONNECTED TO THE EYE BOLT AT THE TOP OF THE POLE (CLEVIS ON THE PULLEYS). THERE ARE (2) "END POLE" PULLEYS AND (4) "LINE POLE" PULLEYS. EACH POLE HAS A LIFTING LINE AS WELL.
3. THE VERTICAL CABLES LOCATED AT THE (2) END POLES SHOULD BE CONNECTED TO THE EYE BOLT AT THE TOP OF THE POLE AND THE CONNECTION PLATES SHOULD BE SLID ON FROM THE BOTTOM AT EACH POLE. ASSEMBLE THE CABLE (QUICK LINK-TURNBUCKLE-QUICK LINK) AND ATTACH THE BOTTOM QUICK LINK TO THE CONNECTION PLATE (LEAVE THE NUTS ON THE U-BOLT OF THE CONNECTION PLATE LOOSE UNTIL THE POLES ARE SET IN THE GROUND SLEEVES).

POLE INSTALLATION

1. INSERT EACH POLE SO THAT THE GROUND NOTCHES LOCK ONTO THE GROUND CABLE CROSS BOLTS.
2. MOVE THE CONNECTION PLATES ON THE (2) END POLES TO THE REQUIRED FINISHED HEIGHT AND TIGHTEN THE NUTS.
3. TENSION THE VERTICAL CABLES USING THE TURNBUCKLES.
4. LOCATE AND INSTALL THE ROPE CLEATS (OPPOSITE OF THE FIELD SIDE).

TOP CABLE AND NET INSTALLATION

1. ORIENTATE THE NET PANEL AND LAY IT ALONG THE GROUND IN LINE WITH THE (4) SUPPORT POLES. LAY THE TOP CABLE ADJACENT TO THE TOP EDGE OF THE NET PANEL AND USE THE STEEL SNAP HOOKS TO ATTACH THE NET TO THE CABLE.
2. LOWER THE LIFTING LINE QUICK LINKS AT EACH POLE. ATTACH TOP STEEL CABLE TO QUICK LINKS AT EACH POLE. USE STEEL SNAP HOOKS TO ATTACH THE TOP OF THE NET PANEL TO THE TOP STEEL CABLE.
3. THE NET PANEL CAN NOW BE RAISED AT EACH POLE - CONNECT THE NET PANEL SIDE EDGES TO THE VERTICAL CABLES USING THE SUPPLIED SNAP HOOKS AS IT IS RAISED. RAISE THE CENTER POLE LIFTING LINE TO THE TOP FIRST AND SECURE IT AT ITS ROPE CLEAT.
4. RAISE THE END POLE LIFTING LINES AND PULL TENSION ON THE TOP CABLE BEFORE SECURING AT THE ROPE CLEATS. (WORK AT BOTH ENDS TO BALANCE THE NET SIDE-TO-SIDE).

REVISION #	BY	DATE
1	JD	02/21/2024